

**DR-2112, DR-2112-P,
DR-2112-R, DR-2112-R-P****Berührungsloser Drehmomentsensor, rotierend
Contactless Torque Sensor, rotating**

- Nenndrehmoment von 0,1 N·m ... 20000 N·m -
Nominal torque from 0.1 N·m ... 20000 N·m
- Genauigkeitsklasse optional 0,05% - *Accuracy class optional 0.05%*
- Aktiver Ausgang ±5V (optional ±10V) - *Active output ±5V (optional ±10V)*
- Drehzahl bis 15000 min⁻¹ - *Speed up to 15000 min⁻¹*
- Integrierte Drehzahl-/Drehwinkelmessung optional -
Integrated speed/angle measurement optional
- Sehr kurze axiale Baulänge - *Very short axial length*
- Hohe Drehsteifigkeit - *High torsional stiffness*
- Zuverlässig und robust - *Reliable and durable*
- Einfache Handhabung und Montage - *Simple handling and assembly*
- Sonderausführungen auf Anfrage - *Special versions on request*

**DR-2412, DR-2412-P,
DR-2412-R, DR-2412-R-P****Berührungsloser Drehmomentsensor, rotierend
Contactless Torque Sensor, rotating**

- Nenndrehmoment von 0,1 N·m ... 20000 N·m -
Nominal torque from 0.1 N·m ... 20000 N·m
- Genauigkeitsklasse optional 0,05% - *Accuracy class optional 0.05%*
- Digitaler Ausgang RS485 - *Digital output RS485*
- Drehzahl bis 15000 min⁻¹ - *Speed up to 15000 min⁻¹*
- Integrierte Drehzahl-/Drehwinkelmessung optional -
Integrated speed/angle measurement optional
- Sehr kurze axiale Baulänge - *Very short axial length*
- Hohe Drehsteifigkeit - *High torsional stiffness*
- Zuverlässig und robust - *Reliable and durable*
- Einfache Handhabung und Montage - *Simple handling and assembly*
- Sonderausführungen auf Anfrage - *Special versions on request*
- Auto-Identifikation von: Messbereich, Serien- Nr.
Kalibrierdatum - *Auto identification of: measuring range, serial number, date of calibration*

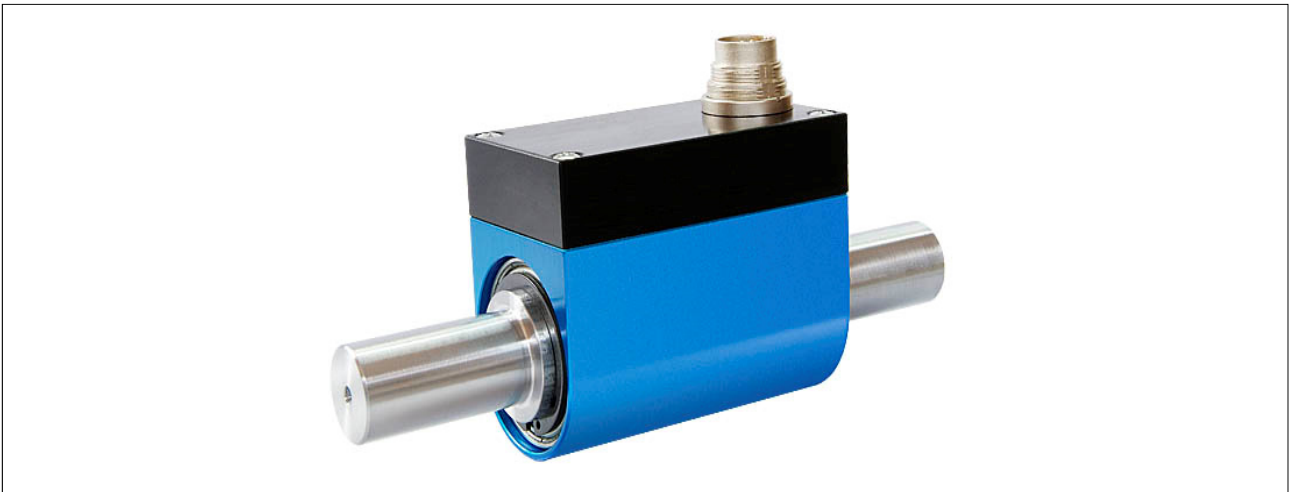

Dieser Sensor hat eine berührungslose und digitale Signalübertragung von Rotor zu Stator, also ohne Signalverfälschung und wartungsfrei.

This sensor has a contactless and digital signal transmission from rotor to stator, which means no signal falsification and maintenance-free.

Technische Daten - Specifications

Artikel-Nr. Article-No. DR-2112	Artikel-Nr. Article-No. DR-2112-P ¹	Nennrehmoment Nominal Torque [N·m]	Grenzdrehzahl Limit Speed [min ⁻¹]	Federkonstante Springrate [N·m/rad]	Massen- trägheits- moment Mass Moment of Inertia [kg·m ²]		Grenzlängskraft Limit Thrust Load [N] ³	Grenzquerkraft Limit Shear Force [N] ⁴
					Antriebsseite Drive Side	Messeite Test Side		
102570	115285	0,1	15000	1,8E+01	1,9E-06	2,8E-07	42	0,9
101930	115284	0,2	15000	1,8E+01	1,9E-06	2,8E-07	58	1,2
101709	115283	0,5	15000	1,2E+02	1,9E-06	2,8E-07	172	1,9
101597	103655	1	15000	1,2E+02	1,9E-06	2,8E-07	227	2,9
102348	114947	2	15000	3,6E+02	1,9E-06	2,9E-07	348	5,5
101840	106697	5	15000	4,0E+02	1,9E-06	2,9E-07	650	14
102761	106847	10	15000	9,3E+02	2,1E-06	3,8E-07	1000	26
102263	105931	20	15000	4,5E+03	1,2E-05	9,9E-06	1680	43
102111	103289	30	15000	4,5E+03	1,2E-05	9,9E-06	2200	65
102451	105943	50	15000	8,5E+03	1,3E-05	1,2E-05	3100	80
101979	104019	100	12000	8,5E+03	1,3E-05	1,2E-05	4800	160
102177	105885	200	10000	6,7E+04	1,0E-04	9,0E-05	8000	290
102316	108437	500	10000	7,1E+04	1,0E-04	9,0E-05	14000	700
103652	115282	1000	8000	3,1E+05	1,6E-03	1,1E-03	23000	900
103349	110873	2000	5500	7,2E+05	5,3E-03	4,3E-03	33000	1200
103797	112778	5000	5500	8,0E+05	5,4E-03	4,3E-03	57000	2800
105483	114737	10000	5000	3,1E+06	4,0E-02	3,7E-02	90000	4400
105484	115297	20000	5000	3,7E+06	4,0E-02	3,8E-02	130000	8200
Artikel-Nr. Article-No. DR-2112-R ⁵	Artikel-Nr. Article-No. DR-2112-R-P	Nennrehmoment Nominal Torque [N·m]	Grenzdrehzahl Limit Speed [min ⁻¹]	Federkonstante Springrate [N·m/rad]	Massen- trägheits- moment Mass Moment of Inertia [kg·m ²]		Grenzlängskraft Limit Thrust Load [N]	Grenzquerkraft Limit Shear Force [N]
					Antriebsseite Drive Side	Messeite Test Side		
108678	113453	0,1	15000	1,8E+01	1,9E-06	2,8E-07	42	0,9
108679	115279	0,2	15000	1,8E+01	1,9E-06	2,8E-07	58	1,2
108680	115280	0,5	15000	1,2E+02	1,9E-06	2,8E-07	172	1,9
108681	115281	1	15000	1,2E+02	1,9E-06	2,8E-07	227	2,9
108682	114491	2	15000	3,6E+02	1,9E-06	2,9E-07	348	5,5
108683	113452	5	15000	4,0E+02	1,9E-06	2,9E-07	650	14
108684	109657	10	15000	9,3E+02	2,1E-06	3,8E-07	1000	26
108686	113223	20	15000	4,5E+03	1,2E-05	9,9E-06	1680	43
108687	113395	30	15000	4,5E+03	1,2E-05	9,9E-06	2200	65
108688	110093	50	15000	8,5E+03	1,3E-05	1,2E-05	3100	80
108689	110500	100	12000	8,5E+03	1,3E-05	1,2E-05	4800	160
108690	110149	200	10000	6,7E+04	1,0E-04	9,0E-05	8000	290
108691	109209	500	10000	7,1E+04	1,0E-04	9,0E-05	14000	700
108692	115278	1000	8000	3,1E+05	1,6E-03	1,1E-03	23000	900

¹ Ausführung „-P“ Passfeder - Version „-P“ feather key

² Ohne Option Drehzahl-/Drehwinkelmessung - Without option speed/angle measurement

³ Ungelagerte Welle - Unsupported shaft

⁴ Ungelagerte Welle - Unsupported shaft

⁵ Ausführung „-R“ Genauigkeitsklasse 0,2% v. Endwert - Version „-R“ accuracy class 0.2% f. scale

Technische Daten - Specifications

Artikel-Nr. Article-No. DR-2412	Artikel-Nr. Article-No. DR-2412-P ⁶	Nennmoment Nominal Torque [N·m]	Grenzdrehzahl Limit Speed [min ⁻¹]	Federkonstante Springrate [N·m/rad]	Massen- trägheits- moment Mass Moment of Inertia [kg·m ²] ⁷		Grenzlängskraft Limit Thrust Load [N] ⁸	Grenzquerkraft Limit Shear Force [N] ⁹
					Antriebsseite Drive Side	Messeite Test Side		
104139	115384	0,1	15000	1,8E+01	1,9E-06	2,8E-07	42	0,9
104140	115387	0,2	15000	1,8E+01	1,9E-06	2,8E-07	58	1,2
104141	115388	0,5	15000	1,2E+02	1,9E-06	2,8E-07	172	1,9
104142	115393	1	15000	1,2E+02	1,9E-06	2,8E-07	227	2,9
104143	115394	2	15000	3,6E+02	1,9E-06	2,9E-07	348	5,5
104144	115395	5	15000	4,0E+02	1,9E-06	2,9E-07	650	14
104145	115397	10	15000	9,3E+02	2,1E-06	3,8E-07	1000	26
104147	115419	20	15000	4,5E+03	1,2E-05	9,9E-06	1680	43
104148	115420	30	15000	4,5E+03	1,2E-05	9,9E-06	2200	65
104149	115427	50	15000	8,5E+03	1,3E-05	1,2E-05	3100	80
104150	115426	100	12000	8,5E+03	1,3E-05	1,2E-05	4800	160
104151	115425	200	10000	6,7E+04	1,0E-04	9,0E-05	8000	290
104152	114155	500	10000	7,1E+04	1,0E-04	9,0E-05	14000	700
104153	115428	1000	8000	3,1E+05	1,6E-03	1,1E-03	23000	900
104154	115480	2000	5500	7,2E+05	5,3E-03	4,3E-03	33000	1200
104155	115481	5000	5500	8,0E+05	5,4E-03	4,3E-03	57000	2800
105871	115482	10000	5000	3,1E+06	4,0E-02	3,7E-02	90000	4400
105782	115483	20000	5000	3,7E+06	4,0E-02	3,8E-02	130000	8200
Artikel-Nr. Article-No. DR-2412-R ¹⁰	Artikel-Nr. Article-No. DR-2412-R-P	Nennmoment Nominal Torque [N·m]	Grenzdrehzahl Limit Speed [min ⁻¹]	Federkonstante Springrate [N·m/rad]	Massen- trägheits- moment Mass Moment of Inertia [kg·m ²]		Grenzlängskraft Limit Thrust Load [N]	Grenzquerkraft Limit Shear Force [N]
					Antriebsseite Drive Side	Messeite Test Side		
108708	115303	0,1	15000	1,8E+01	1,9E-06	2,8E-07	42	0,9
108709	115307	0,2	15000	1,8E+01	1,9E-06	2,8E-07	58	1,2
108710	115306	0,5	15000	1,2E+02	1,9E-06	2,8E-07	172	1,9
108711	115308	1	15000	1,2E+02	1,9E-06	2,8E-07	227	2,9
108712	115309	2	15000	3,6E+02	1,9E-06	2,9E-07	348	5,5
108713	115310	5	15000	4,0E+02	1,9E-06	2,9E-07	650	14
108714	115311	10	15000	9,3E+02	2,1E-06	3,8E-07	1000	26
108716	115305	20	15000	4,5E+03	1,2E-05	9,9E-06	1680	43
108717	115312	30	15000	4,5E+03	1,2E-05	9,9E-06	2200	65
108718	115313	50	15000	8,5E+03	1,3E-05	1,2E-05	3100	80
108719	114722	100	12000	8,5E+03	1,3E-05	1,2E-05	4800	160
108720	115304	200	10000	6,7E+04	1,0E-04	9,0E-05	8000	290
108721	112568	500	10000	7,1E+04	1,0E-04	9,0E-05	14000	700
108722	115302	1000	8000	3,1E+05	1,6E-03	1,1E-03	23000	900

⁶ Ausführung „-P“ Passfeder - Version „-P“ feather key

⁷ Ohne Option Drehzahl-/Drehwinkelmessung - Without option speed/angle measurement

⁸ Ungelagerte Welle - Unsupported shaft

⁹ Ungelagerte Welle - Unsupported shaft

¹⁰ Ausführung „-R“ Genauigkeitsklasse 0,2% v. Endwert - Version „-R“ accuracy class 0.2% f. scale

		DR-2112, DR-2112-P (DR-2112-R, DR-2112-R-P)	DR-2412, DR-2412-P (DR-2412-R, DR-2412-R-P)
Genauigkeitsklasse - <i>Accuracy class</i>	% v. E. - f. s.	0,1 (0,2)	
Reproduzierbarkeit - <i>Repeatability</i> (DIN 1319)	%	±0,02 (±0,04)	
Versorgung - <i>Supply voltage</i>	VDC	12 ... 28	
Stromaufnahme - <i>Current consumption</i>	mA	≤60	
Ausgangssignal - <i>Output signal</i>		±5V	±25000 Digits
Kontrollsignalaufschaltung - <i>Control signal excitation</i>	V	L <2,0; H >3,5	per Software
Messrate - <i>Sample rate</i>	kSample/s	10	5
Referenztemperatur - <i>Reference temperature</i>	°C	23	
Nenntemperaturbereich - <i>Nominal temperature range</i>	°C	5 ... 45	
Gebrauchstemperaturbereich - <i>Service temperature range</i>	°C	0 ... 60	
Lagerungstemperaturbereich - <i>Storage temperature range</i>	°C	-10 ... 70	
Temp. koef. des Kennwerts - <i>Temp. coeff. of sensitivity</i>	% v. E./K - f. s./K	±0,01 (±0,015)	
Temp. koef. des Nullsignals - <i>Temp. coeff. of zero signal</i>	% v. E./K - f. s./K	±0,02 (±0,03)	
Gebrauchsdrehmoment (statisch) - <i>Service torque (static)</i>	% v. E. - f. s.	150	
Grenzdrehmoment (statisch) - <i>Limit torque (static)</i>	% v. E. - f. s.	200	
Bruchdrehmoment (statisch) - <i>Ultimate torque (static)</i>	% v. E. - f. s.	>300	
Schwingbreite - <i>Bandwidth</i> (DIN 50100)	%	70 (Spitze - Spitze) - (<i>peak - peak</i>)	
Schutzart - <i>Level of protection</i> (DIN EN 60529)		IP50	
Elektrischer Anschluss - <i>Electrical connection</i>		12-polig Serie 581 - <i>12-pin series 581</i> ¹¹	



Anschlussbelegung - Pin Connection

12-polig - 12-pin	DR-2112, DR-2112-R, DR-2112-P, DR-2112-R-P		
Pin A	NC	-	<p>Serie - Series 581</p> <p>Draufsicht - Top view</p>
Pin B	Opt. Signal Winkel B - <i>Opt. Signal angle B</i>	5V TTL	
Pin C	Signal (+) - <i>Signal (+)</i>	±5V (±10V)	
Pin D	Signal (GND) - <i>Signal (GND)</i>	0V	
Pin E	Vers. (GND) - <i>Supply (GND)</i>	0V	
Pin F	Vers. (+) - <i>Supply (+)</i>	12 ... 28VDC	
Pin G	Opt. Signal Winkel A - <i>Opt. Signal angle A</i>	5V TTL	
Pin H	NC	-	
Pin J	NC	-	
Pin K	Kontrollsignal - <i>Control signal</i>	L <2,0V; H >3,5V	
Pin L	NC	-	
Pin M	Schirm - <i>Shield</i>	-	

12-polig - 12-pin	DR-2412, DR-2412-R, DR-2412-P, DR-2412-R-P		
Pin A	NC	-	<p>Serie - Series 581</p> <p>Draufsicht - Top view</p>
Pin B	NC	-	
Pin C	NC	-	
Pin D	NC	-	
Pin E	Vers. (GND) - <i>Supply (GND)</i>	0V	
Pin F	Vers. (+) - <i>Supply (+)</i>	12 ... 28VDC	
Pin G	NC	-	
Pin H	NC	-	
Pin J	RS485	RS485 (B)	
Pin K	NC	-	
Pin L	RS485	RS485 (A)	
Pin M	Schirm - <i>Shield</i>	-	

¹¹ Kabeldose bei Erstauslieferung im Lieferumfang enthalten - *Female cable connector in scope of delivery at first delivery*

Optionen/ Zubehör - Options/ Accessories

Artikel-Nr. - Article-No.	Bezeichnung - Description		
101695	Genauigkeitsklasse - Accuracy class	% v. E. - f. s.	0,05
103562	Ausgangssignal - Output signal	V	±10
101560 ¹²	Drehzahl-/Drehwinkelmessung, 2x360 Impulse, 90° versetzt, 5V TTL - Speed/angle measurement, 2x360 impulses, 90° displaced, 5V TTL		Rechtsdrehung - CW-turn CH A  CH B 
115391 ¹³	Drehzahl-/Drehwinkelmessung, RS485 - Speed/angle measurement, RS485		
	Auflösung Drehzahl - Speed resolution	min ⁻¹	1
	Genauigkeit Drehzahl - Speed accuracy	% v. E. - f. s.	1 ±1 Digit
	Auflösung Drehwinkel - Angle of rotation resolution	Grad - degree	0,25
	Ausgangssignal Drehzahl/ Drehwinkel - Output signal speed/ angle of rotation	Digits	±32.511
104097 ¹⁴	Drehzahlmessung, 1x60 Impulse, 5V TTL - Speed measurement, 1x60 impulses, 5V TTL		
41382	Kabeldose 12-polig Serie 581 - Female cable connector 12-pin series 581		
45598	Winkeldose 12-polig Serie 682 - Female angled connector 12-pin series 682		
10270	Anschlusskabel, 3 m, mit 12-pol. Kabeldose Serie 581 und freien Lötenden - Connection cable, 3 m, with 12-pin female cable connector series 581 and free soldered ends		
10345	Anschlusskabel winklig, 3 m, mit 12-pol. Kabeldose Serie 682 und freien Lötenden - Connection cable angled, 3 m, with 12-pin female cable connector series 682 and free soldered ends		

Option Kalibrierungen - Option Calibrations

Artikel-Nr. - Article-No.	Bezeichnung - Description	Stufen - Steps	Norm - Norm
400676	Linearitätsdiagramm - Linearity diagram	25%	Werksnorm - Factory standard
400664	Linearitätsdiagramm - Linearity diagram	10%	
400961	Werkskalibrierung - Proprietary calibration	3	VDI/VDE 2646
400700	Werkskalibrierung - Proprietary calibration	5	
400688	Werkskalibrierung - Proprietary calibration	8	
	DAkKS-Kalibrierung - DAKKS-Calibration		auf Anfrage - on request

¹² Für DR-2112, DR-2112-P, DR-2112-R, DR-2112-R-P - For DR-2112, DR-2112-P, DR-2112-R, DR-2112-R-P

¹³ Für DR-2412, DR-2412-P, DR-2412-R, DR-2412-R-P - For DR-2412, DR-2412-P, DR-2412-R, DR-2412-R-P

¹⁴ Nenn Drehmoment ≥2000 N·m - Nominal torque ≥2000 N·m

Mechanische Abmessungen - Dimensions

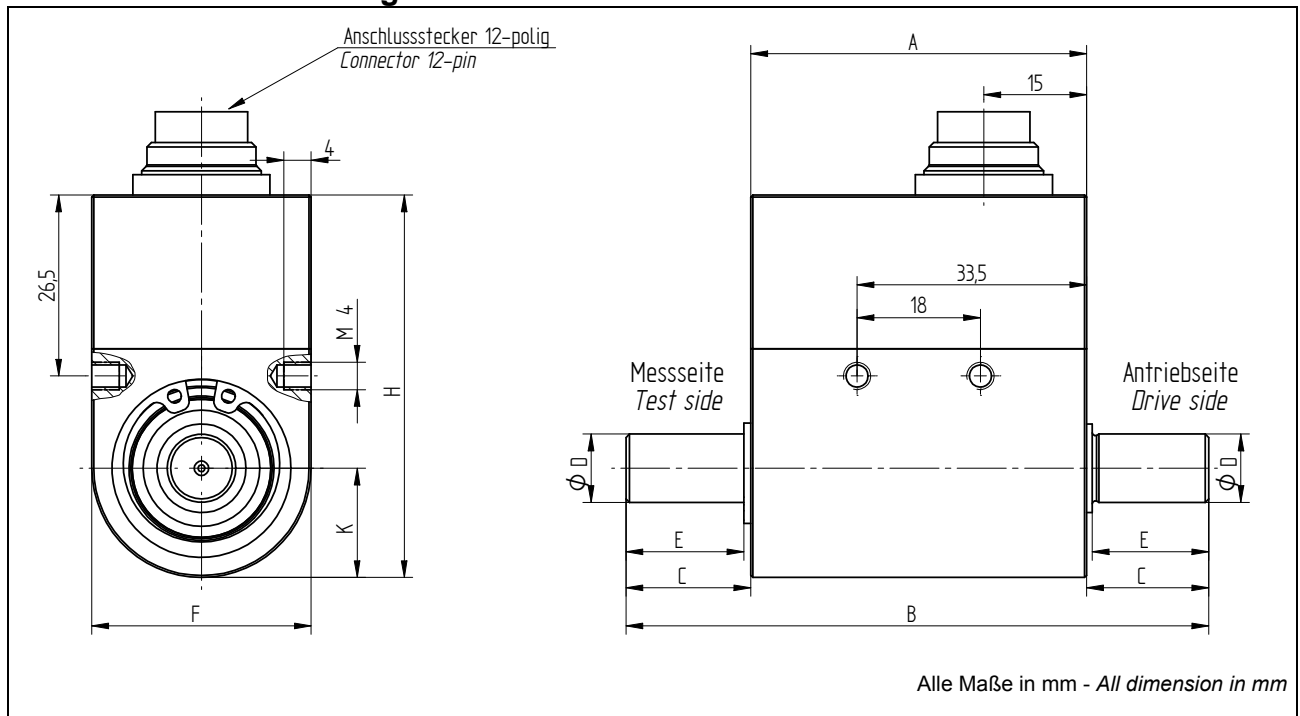

Alle Maße in mm - All dimension in mm

Nenn Drehmoment - Nominal Torque [N·m]	Abmessungen - Dimensions [mm]							
	A	B	C	Ø D	E	F	H	K
0,1 / 0,2 / 0,5 / 1 / 2 / 5	49	85	18	8 g6	17	32	56	16
10	49	85	18	10 g6	17	32	56	16

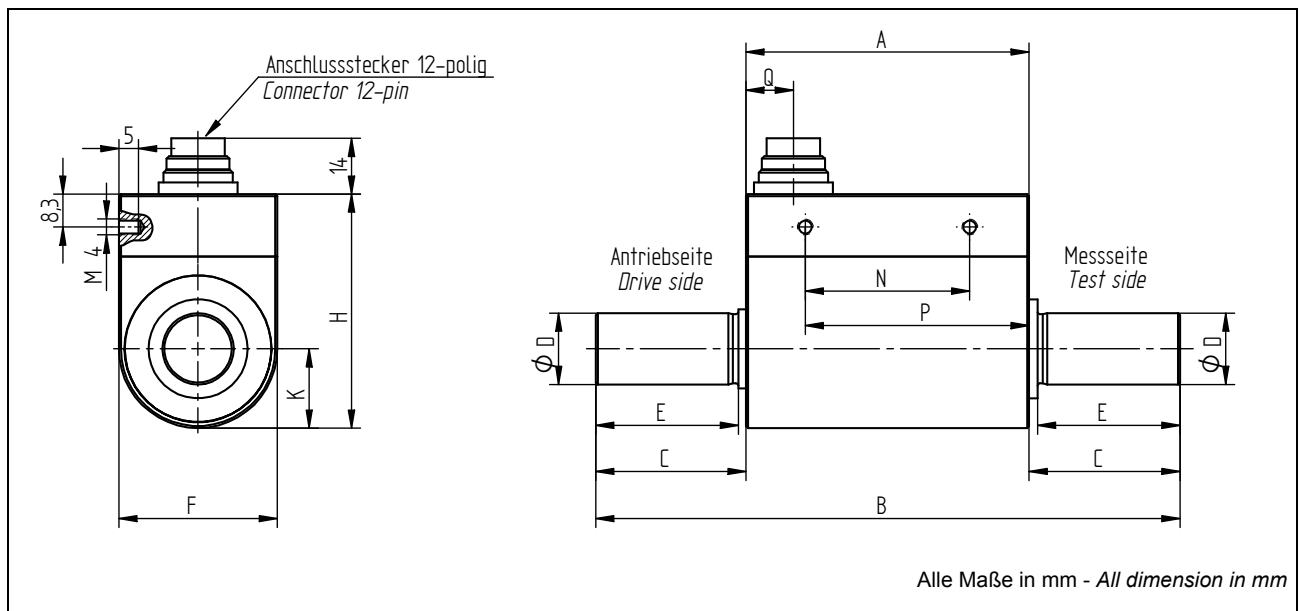

Alle Maße in mm - All dimension in mm

Nenn Drehmoment - Nominal Torque [N·m]	Abmessungen - Dimensions [mm]											
	A	B	C	Ø D	E	F	H	K	M	N	P	Q
20 / 30	71,5	111,5	20	18 g6	18	40	59	20	5	41,5	56,5	12
50 / 100	71,5	147,5	38	18 g6	36	40	59	20	5	41,5	56,5	12
200 / 500	72,5	159,5	43,5	32 g6	38	58	76	29	6	29,5	51,5	15

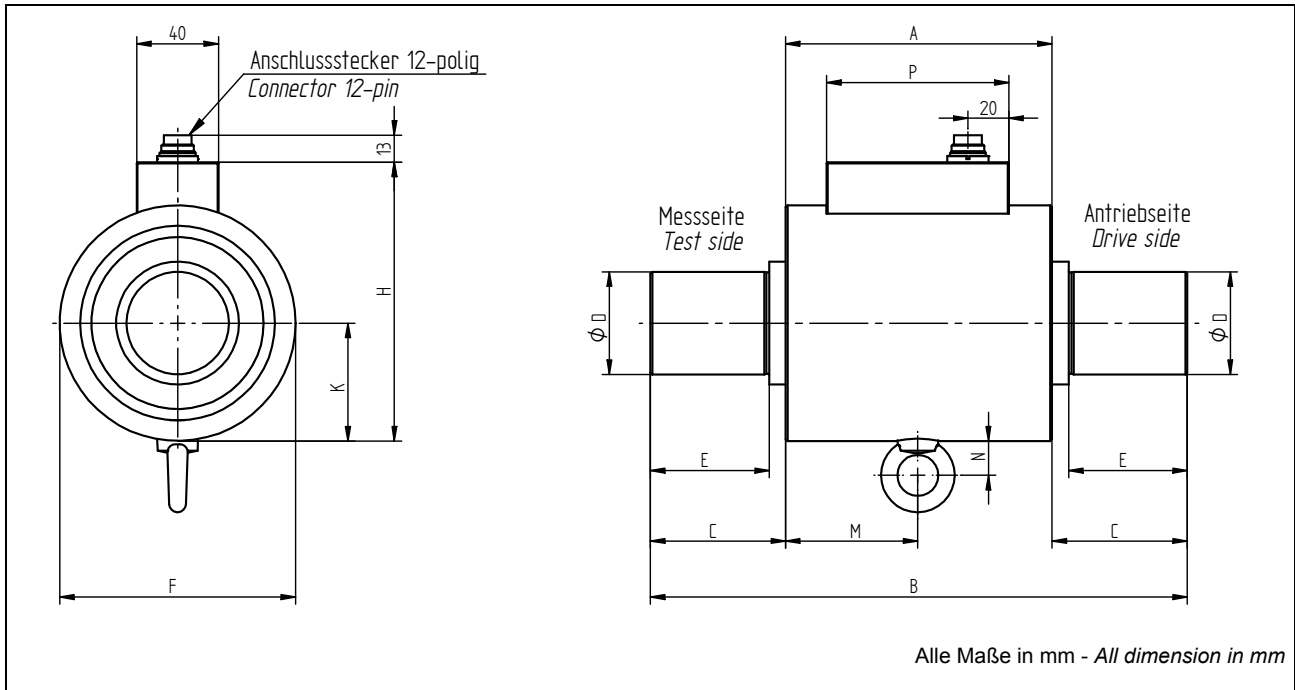

Nenn Drehmoment - Nominal Torque [N·m]	Abmessungen - Dimensions [mm]										
	A	B	C	Ø D	E	F	H	K	M	N	P
1000	130	262	66	50 g6	58	115	136	57,5	65,5	18	89
2000 / 5000	135	377	121	70 g6	110	139	161	69,5	67,5	18	89
10000 / 20000	190	470	140	110 g6	120	210	233	109	95	18	89

Ausführung Passfeder - Version Feather Key

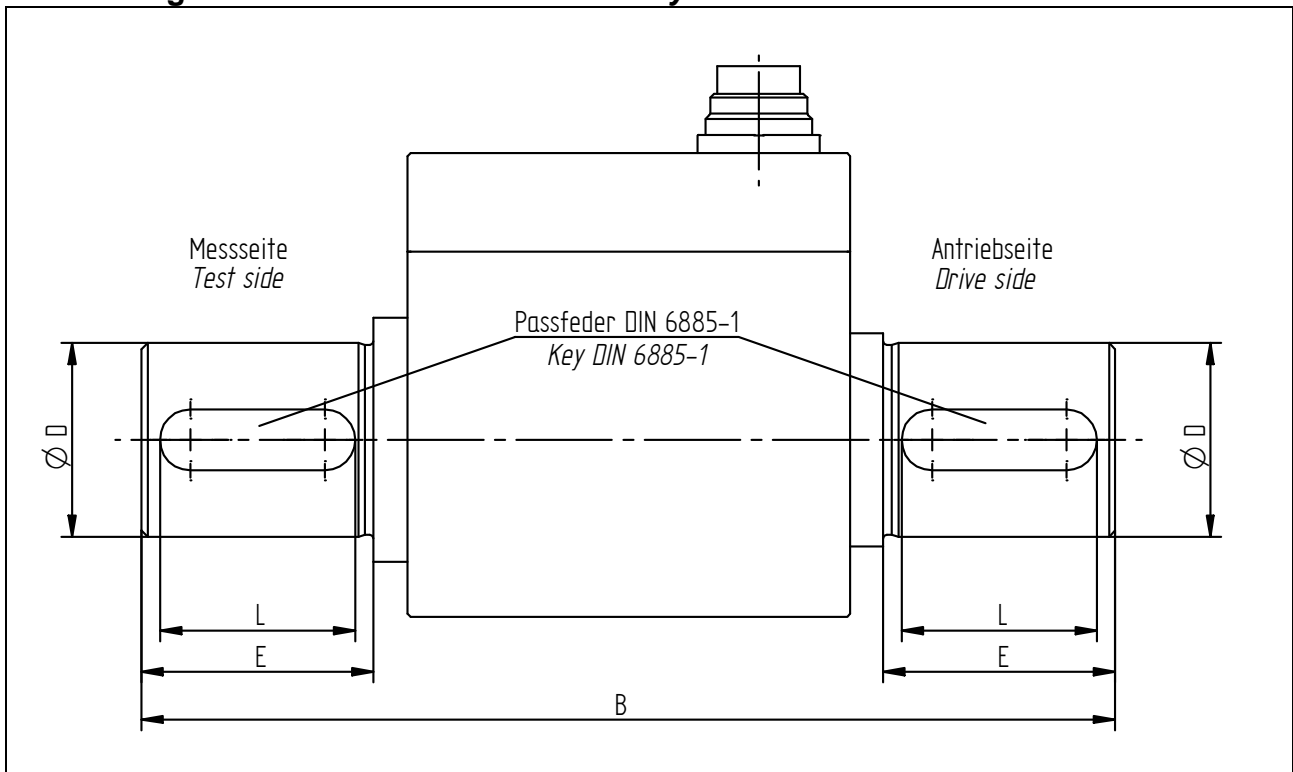

Nenn Drehmoment - Nominal Torque [N·m]	Abmessungen - Dimensions [mm]				
	B	Ø D	E	L	Passfeder - Feather Key ¹⁵
0,1 / 0,2 / 0,5 / 1 / 2 / 5	85	8 g6	17	14	2 x 2 x 14
10	85	10 g6	17	14	3 x 3 x 14
20 / 30	111,5	18 g6	18	14	6 x 6 x 14
50 / 100	147,5	18 g6	36	30	6 x 6 x 30
200 / 500	159,5	32 g6	38	36	10 x 8 x 36
1000	262	50 g6	58	50	14 x 9 x 50
2000 / 5000	377	70 g6	110	100	20 x 12 x 100
10000 / 20000	570	110 g6	170	160	28 x 16 x 160

¹⁵ Passfeder berechnete Belastungsart, einseitig leichte Stöße - Calculated load type for feather key are single side light shocks