



Operation Manual for Torque Sensors with Slip Ring Transmission

For below and similar Types



DR-1



DR-2



DR-12



DR-20



DR-2291



DR-2335



Imprint

| | |
|----------------------|---|
| Manufacturer, Place | Lorenz Messtechnik GmbH, D-73553 Alfdorf |
| Valid for... | Torque Sensors with Slip Ring Transmission |
| Copyright | © 2006 Lorenz Messtechnik GmbH, Alfdorf |
| Reprint-Interdiction | Reprint, even in extracts, only with written authorization. |
| Modification | Technical changes reserved. |

References in this Text

1.6 Warning Notes; Page 5



Attention must be paid to the accident prevention regulations of the trade associations. Coverings and casings are necessary before operating the sensor. This is also valid for commissioning, maintenance and trouble shooting.

Duties of the coverings and casings are:

- ⇒ Protection from detaching parts
- ⇒ Protection from contusion and shear
- ⇒ Prevention from reaching rotating parts
- ⇒ Prevention from being tangled up and/or getting caught by parts

Coverings may

- ⇒ Not grind
- ⇒ Not rotate

Coverings are also necessary outside of operating and motion travel areas of persons. These demands can be modified if other sufficient safety devices are available. During operation, the safety precautions must be operative. By vibrations, damages can occur at hand-guided devices which can lead to injuries.

4 Mechanical Assembly; Page 7



Caution: During the assembly inadmissibly large forces may not act on the sensor or the couplings. At small torques (< 20 N·m) connect the sensor electrically during the assembly and observe the signal, the measurement signal may not exceed the limit values.



During the assembly the sensor must be supported to protect it from falling down.

4.1 Assembly of Slip Ring Torque Sensors; Page 7



Caution at Permutation of Drive Side and Measuring Side:

- Friction of the slip rings will influence the measuring signal,
- At dynamic measurements, a restricted measurement accuracy has to be expected by the higher inert mass and the damping effect of the slip rings.

Therefore always consider Drive Side and Measuring Side!

4.4.1 Shaft-Shaft Freefloating Assembly; Page 7



Before the assembly, shafts and hubs must be cleaned with dissolver (e.g. acetone), no foreign particles may adhere to them. The hub must fit corresponding to the connection.

4.1.2 Inside and Outside Hexagon (-Square); Page 8



Caution: Do not use pulse or impact wrenches!

6.1 Engaging; Page 11



Warming-up period of the torque sensor is approx. 5 min.

6.4.2 Natural Resonances; Page 11



An operation of the device in natural resonance can lead to permanent damages.

7.1 Maintenance Schedule; Page 13



Caution: Do not bend brushes while cleaning!



Contents

| | | |
|-------|--|----|
| 1 | Read First..... | 4 |
| 1.1 | Safety and Caution Symbols..... | 4 |
| 1.2 | Intended Use..... | 4 |
| 1.3 | Dangers..... | 4 |
| 1.3.1 | Neglecting of Safety Notes..... | 4 |
| 1.3.2 | Remaining Dangers..... | 4 |
| 1.4 | Reconstructions and Modifications..... | 4 |
| 1.5 | Personnel..... | 4 |
| 1.6 | Warning Notes..... | 5 |
| 2 | Term Definitions..... | 5 |
| 2.1 | Terms..... | 5 |
| 2.2 | Definition of the Pictograms on the Torque Sensor..... | 5 |
| 3 | Product Description..... | 6 |
| 3.1 | Torque Sensor with Slip Ring, Torque Sensor with Rotating Shaft..... | 6 |
| 3.1.1 | Mechanical Setup..... | 6 |
| 3.1.2 | Electrical Setup..... | 6 |
| 4 | Mechanical Assembly..... | 7 |
| 4.1 | Assembly of Slip Ring Torque Sensors..... | 7 |
| 4.1.1 | Shaft-Shaft Freefloating Assembly..... | 7 |
| 4.1.2 | Inside and Outside Hexagon (-Square)..... | 8 |
| 4.2 | Couplings..... | 8 |
| 4.2.1 | Single-Jointed Couplings..... | 8 |
| 4.2.2 | Misalignment Possibilities of Single-Jointed Couplings..... | 8 |
| 4.2.3 | Alignment of the Measurement Arrangement..... | 9 |
| 5 | Electrical Connection..... | 9 |
| 5.1 | Pin Connection..... | 9 |
| 5.2 | Cable..... | 9 |
| 5.3 | Shielding Connection..... | 9 |
| 5.4 | Extension Cable..... | 10 |
| 5.5 | Running of Measuring Cables..... | 10 |
| 5.6 | Angle (Option)..... | 10 |
| 6 | Measuring..... | 11 |
| 6.1 | Engaging..... | 11 |
| 6.2 | Direction of Torque..... | 11 |
| 6.3 | Static / Quasi-Static Torques..... | 11 |
| 6.4 | Dynamic Torques..... | 11 |
| 6.4.1 | General..... | 11 |
| 6.4.2 | Natural Resonances..... | 11 |
| 6.5 | Calibration Control (Option)..... | 12 |
| 6.6 | Speed Limits..... | 12 |
| 6.7 | Disturbance Variables..... | 12 |
| 7 | Maintenance..... | 13 |
| 7.1 | Maintenance Schedule..... | 13 |
| 7.2 | Trouble Shooting..... | 14 |
| 8 | Decommission..... | 14 |
| 9 | Transportation and Storage..... | 14 |
| 9.1 | Transportation..... | 15 |
| 9.2 | Storage..... | 15 |
| 10 | Disposal..... | 15 |
| 11 | Calibration..... | 15 |
| 11.1 | Proprietary Calibration..... | 15 |
| 11.2 | DKD-Calibration..... | 15 |
| 11.3 | Re-Calibration..... | 15 |
| 12 | Data Sheet..... | 15 |
| 13 | Literature..... | 15 |



1 Read First

1.1 Safety and Caution Symbols

**Caution:**

Injury Risk for Persons
Damage of the Device is possible

Note:

Important points to be considered

1.2 Intended Use

Torque sensors are intended for the measurement of torques. This measurand is further suitable for control tasks. The valid safety regulations should be absolutely respected. The torque sensors are not safety components in the sense of the intended use. The sensors need to be transported and stored appropriately. The assembly, commissioning and disassembling must take place professionally.

1.3 Dangers

The torque sensor is fail-safe and corresponds to the state of technology.

1.3.1 Neglecting of Safety Notes

At inappropriate use, remaining dangers can emerge (e.g. by untrained personnel). The operation manual must be read and understood by each person entrusted with the assembly, maintenance, repair, operation and disassembly of the torque sensor.

1.3.2 Remaining Dangers

The plant designer, the supplier, as well as the operator must plan, realize and take responsibility for safety-related interests for the sensor. Remaining dangers must be minimized. Remaining dangers of the torque measurement technique must be pointed out.

Human mistakes must be considered. The construction of the plant must be suitable for the avoidance of dangers. A danger-analysis for the plant must be carried out.

1.4 Reconstructions and Modifications

Each modification of the sensors without our written approval excludes liability on our part.

1.5 Personnel

The installation, assembly, commissioning, operation and the disassembly must be carried out by qualified personnel only. The personnel must have the knowledge and make use of the legal regulations and safety instructions.



1.6 Warning Notes



Attention must be paid to the accident prevention regulations of the trade associations. Coverings and casings are necessary before operating the sensor. This is also valid for commissioning, maintenance and trouble shooting.

Duties of the coverings and casings are:

- ⇒ Protection from detaching parts
- ⇒ Protection from contusion and shear
- ⇒ Prevention from reaching rotating parts
- ⇒ Prevention from being tangled up and/or getting caught by parts

Coverings may

- ⇒ Not grind
- ⇒ Not rotate

Coverings are also necessary outside of operating and motion travel areas of persons. These demands can be modified if other sufficient safety devices are available. During operation, the safety precautions must be operative. By vibrations, damages can occur at hand-guided devices which can lead to injuries.

2 Term Definitions

2.1 Terms

Measuring Side:

Mechanical connection of the torque sensor in which the torque to be measured is applied. Usually this side has the smallest moment of inertia.

Drive Side:

Mechanical connection of the torque sensor on the opposite side of the measuring side, usually with the largest moment of inertia. At static torque sensors the housing is fastened on this side.

Low Torque Resistance Side:

The shaft of the arrangement (drive, load) which can be turned considerably smaller with torque than the nominal torque of the torque sensor $M \ll M_{\text{enn}}$.

2.2 Definition of the Pictograms on the Torque Sensor

The measuring side of the torque sensor is designated as follows:

Measuring side:  or M

More information can be found on the data sheet, if needed.

3 Product Description

Measurement of following static and dynamic measurement categories:

- Torque,
- Speed at sensors with speed measurement,
- Angle at sensors with angle measurement.

Caution: it must be differentiated between drive side and measuring side, see data sheet of the sensor:
www.lorenz-sensors.com

3.1 Torque Sensor with Slip Ring, Torque Sensor with Rotating Shaft

3.1.1 Mechanical Setup

The sensor is equipped with slip rings for the transmission of the supply voltage and the measuring signal.

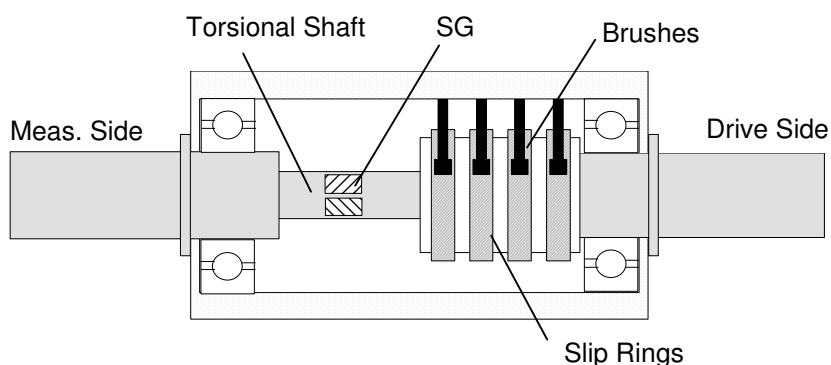

Sectional view through the torque sensor

Slip ring sensors - depending on design - consist of a torsional shaft with different connection possibilities (shafts, square, hexagonal etc.). The torque shaft, applied with strain gauges, is placed in a housing with ball bearings. For the signal transmission or for the supply of the SG full bridge, a slip ring rotating transformer is arranged in the sensor. It consists of four slip rings on the shaft and fastened brushes at the stator. A connector or a cable connection is fixed at the housing.

3.1.2 Electrical Setup

The strain gauge full bridge is directly connected at the plug or at the cable.

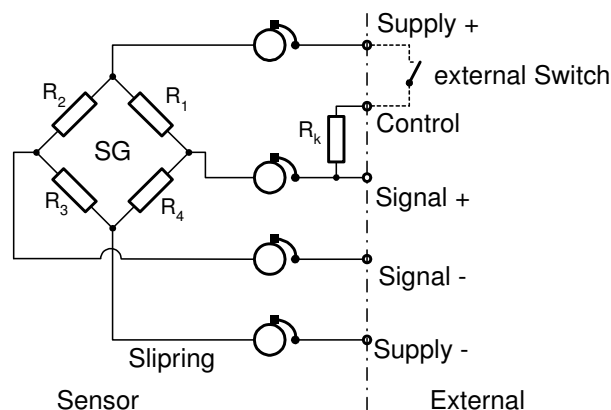

Principle sketch for slip ring sensors with strain gauge full bridge and option calibration control.



4 Mechanical Assembly



Caution: During the assembly inadmissibly large forces may not act on the sensor or the couplings. At small torques (< 20 N·m) connect the sensor electrically during the assembly and observe the signal, the measurement signal may not exceed the limit values.



During the assembly the sensor must be supported to protect it from falling down.

4.1 Assembly of Slip Ring Torque Sensors

At these sensors it must be differentiated between measuring side and drive side. At the drive side, the slip ring rotating transformer is located and its inevitable friction at permuted installation position (measuring side permuted with drive side) influences the measurement. For the position of the measuring side see data sheet of the sensor (www.lorenz-sensors.com).

In order to avoid abrasive dust from reaching into the brush connections, it is recommended to adjust the cable connection upwards.



Caution at Permutation of Drive Side and Measuring Side:

- Friction of the slip rings will influence the measuring signal,
- At dynamic measurements, a restricted measurement accuracy has to be expected by the higher inert mass and the damping effect of the slip rings.

Therefore always consider Drive Side and Measuring Side!

4.1.1 Shaft-Shaft Freefloating Assembly

The sensor is installed between two single-jointed couplings and contributes to the balance of an inevitable axis offset between the two mechanical connections.

If not using couplings, very large lateral forces can affect the sensor. In addition, large forces occur on bearings, drive and specimen, which limit their life span very strongly.

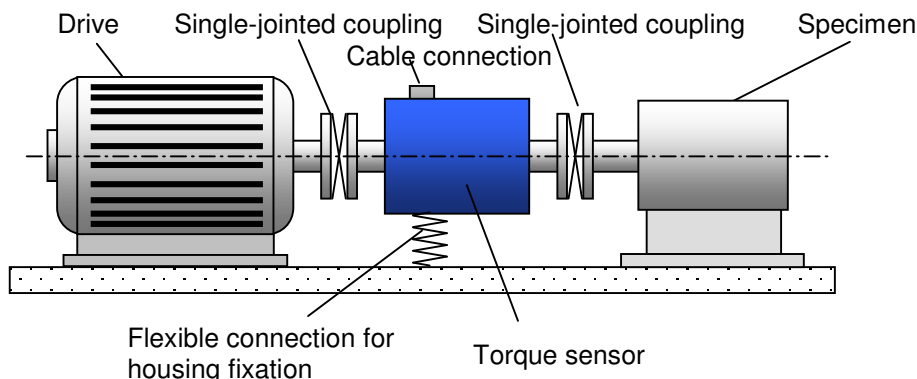

Before the assembly, shafts and hubs must be cleaned with dissolver (e.g. acetone), no foreign particles may adhere to them. The hub must fit corresponding to the connection.

Connections with Clamping Piece:

The indications of the clamping piece manufacturer must be considered. The clamping piece must be able to safely transfer the emerging torques.

Feather Key Connections:

The hub must be secured from slipping out (e.g. by safety screw on feather key, or axial screw).

The housing must be protected from twisting e.g. by a flexible connection. The cable connection may not be used for this.

The cable connection must be placed loosely (form of goose neck), so that it can follow the light movements of the stator.



Thread for the fixation of a flexible rotary protection

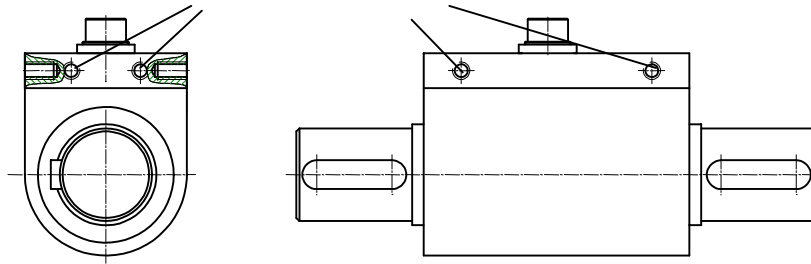

Example of the fixation of the rotary protection.

4.1.2 Inside and Outside Hexagon (-Square)

Typical Application

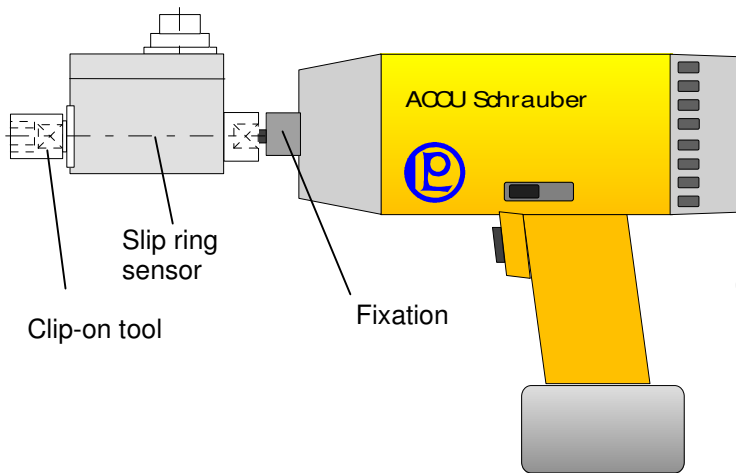

Hazards by vibrations must be avoided!

☞ Caution: Do not use pulse or impact wrenches!

4.2 Couplings

For this, see corresponding data sheet

4.2.1 Single-Jointed Couplings

For this torque sensor we recommend the couplings intended by Lorenz Messtechnik GmbH which must be able to balance an axial, radial or angular offset of the shafts and not allow large forces to act on the sensor. Couplings with keyways are used.

4.2.2 Misalignment Possibilities of Single-Jointed Couplings

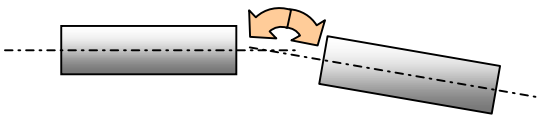

Angular misalignments

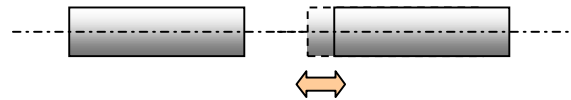

Axial misalignments

Note: Radial misalignments are only possible in the combination of single-jointed coupling - torque sensor (as adapter) - single-jointed coupling.

Thus, with both single-jointed couplings the torque sensor forms a double-jointed coupling. The arrangement can balance radial misalignments as well.

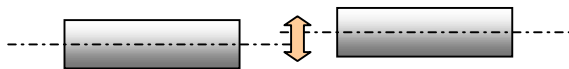

Radial misalignments



4.2.3 Alignment of the Measurement Arrangement

Precisely alignment of the couplings reduces the reaction forces and increases the durability of the couplings. Disturbance variables are minimized as well.

Due to the multitude of applications, an alignment of the coupling with a straight edge in two levels, vertical to each other, is sufficient.

5 Electrical Connection

5.1 Pin Connection

| 6-pin | Function |
|-------|--------------------------|
| 1 | SG- excitation - |
| 2 | SG- excitation + |
| 3 | Shield |
| 4 | SG- signal + |
| 5 | SG- signal - |
| 6 | 100% calibration control |

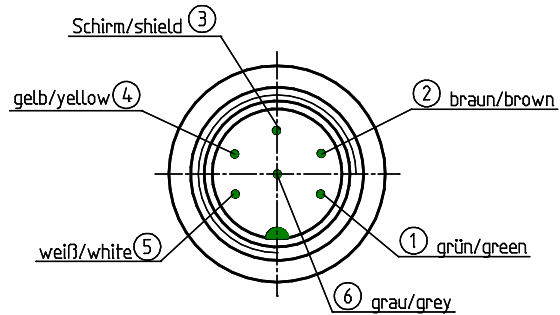

| 12-pin | Function |
|--------|--------------------------|
| A | SG- excitation - |
| B | SG- excitation + |
| C | SG- signal + |
| D | SG- signal - |
| E | Excitation Angle - |
| F | Excitation Angle + |
| G | Angle A (TTL) |
| H | Angle B (TTL) |
| J | Angle - |
| K | 100% calibration control |
| L | - |
| M | Shield |

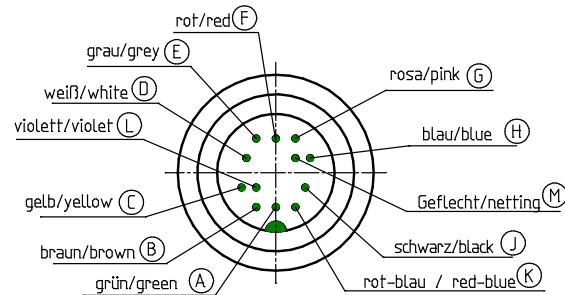

View: socket on soldering side

See attached test certificate

5.2 Cable

Only use a shielded cable with preferably small capacity. We recommend measuring cables from our product range. They have been tested in combination with our sensors and meet the metrological requirements.

5.3 Shielding Connection

In combination with the sensor and the external electronics, the shield forms a Faraday Cage. By this, electro-magnetic disturbances do not have any influence on the measurement signal. At potential difference problems we recommend to ground the sensor.



5.4 Extension Cable

Caution: depending on bridge resistance and wire cross section, the measuring cable length enters into the characteristic value of the sensor. Therefore order the sensor together with the extension cable and the calibration at Lorenz Messtechnik GmbH.

Dependence of the characteristic value on the cable length:

| Wire-cross section | Cable resistance per m | Deviation per m cable length at bridge resistance 350 Ω | Deviation per m cable length at bridge resistance 700 Ω | Deviation per m cable length at bridge resistance 1000 Ω |
|----------------------|------------------------|--|--|---|
| 0,14 mm ² | 0,28 Ω | 0,08 % | 0,04 % | 0,028 % |
| 0,25 mm ² | 0,16 Ω | 0,046 % | 0,023 % | 0,016 % |
| 0,34 mm ² | 0,12 Ω | 0,034 % | 0,017 % | 0,012 % |

Cable resistance = 2 x resistance of the cable length (both feed lines of the sensor).

The sensors with the ordered cable length are calibrated at Lorenz Messtechnik GmbH. Therefore the cable length does not need to be considered in this case.

5.5 Running of Measuring Cables

Do not run measuring cables together with control or heavy-current cables. Always assure that a large distance is kept to engines, transformers and contactors, because their stray fields can lead to interferences of the measuring signals.

If troubles occur through the measuring cable, we recommend to run the cable in a grounded steel conduit.

5.6 Angle (Option)

At angle or speed measurement, the pulses / revolutions are acquired. By a second transmitter trace, displaced by 90° and flank evaluation, the pulses / revolutions can be quadrupled. The trace, displaced by 90°, can also be used for the rotational direction detection.

See corresponding data sheet for the output levels.

Supply for angle sensor

| | |
|---------------------------|------------|
| Stabilized supply voltage | 5 V ±25 mV |
| Current consumption max. | 20 mA |

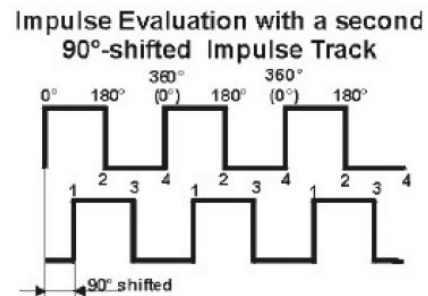



6 Measuring

6.1 Engaging

The warming-up period of the torque sensor is approx. 5 min. Afterwards the measurement can be started.



The warming-up period of the torque sensor is approx. 5 min.

6.2 Direction of Torque

Torque means clockwise or counter-clockwise torque if the torque acts clockwise when facing the shaft end. In this case a positive electrical signal is obtained at the output.

Torque sensors by Lorenz Messtechnik GmbH can measure both, clockwise and counter-clockwise direction.

6.3 Static / Quasi-Static Torques

Static and/or quasi-static torque is a slowly changing torque.

The calibration of the sensors occurs statically on a calibration device.

The applied torque may accept any value up to the nominal torque.

6.4 Dynamic Torques

6.4.1 General

The static calibration procedure of torque sensors is also valid for dynamic applications.

Note: The frequency of torques must be smaller than the natural frequency of the mechanical measurement setup.

The band width of alternating torque must be limited to 70 % of the nominal torque.

6.4.2 Natural Resonances

Estimate of the mechanical natural frequencies:

$$f_0 = \frac{1}{2 \cdot \pi} \cdot \sqrt{c \cdot \left(\frac{1}{J_1} + \frac{1}{J_2} \right)}$$

f_0 = Natural Frequency in Hz
 J_1, J_2 = Moment of Inertia in kg*m²
 c = Torsional Rigidity in Nm/rad

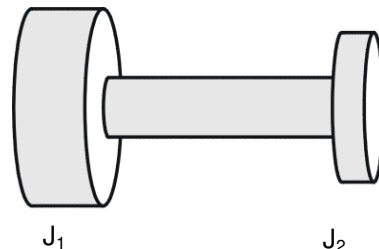

Further methods for the calculation of natural resonances are corresponding purchasable programs or books (e.g. Holzer-Procedure, Dubbel, Taschenbuch für den Maschinenbau, Springer Verlag)



Operation of the device in natural resonance can lead to permanent damages.

6.5 Calibration Control (Option)

By a control resistance, a signal is generated in the sensor which corresponds to the nominal value of the sensor.

Advantage:

Re-Calibrations are reduced. Before each measurement the zero point and the nominal value can be checked.

Function:

By applying positive SG supply, the measuring bridge is electrically detuned, so that at the output a measuring signal of 100% of the nominal value is available.

Optionally 50%, 80% possible.

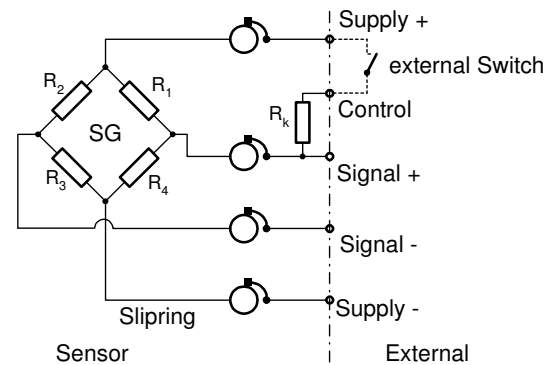

Use calibration control at unloaded torque sensor, only.

6.6 Speed Limits

The maximum speed indicated in the data sheet may not be exceeded in any operating state..

6.7 Disturbance Variables

By disturbances, measured value falsifications can occur by

- Vibrations,
- Temperature gradients,
- Temperature changes,
- Arising disturbance variables during operation, e.g. imbalance,
- Electrical disturbances,
- Magnetic disturbances,
- EMC (electromagnetic disturbances),

Therefore avoid these disturbance variables by decoupling of vibrations, covers, etc.



7 Maintenance

7.1 Maintenance Schedule

| Action | Frequency | Date | Date | Date |
|---------------------------------------|-------------|------|------|------|
| Control of cables and connectors | 1x p.a. | | | |
| Calibration | < 26 months | | | |
| Control of fixation (flanges, shafts) | 1x p.a. | | | |

The durability of the brushes is limited; it is depending on speed, number of revolutions and construction size.

We recommend to renew the brushes at Lorenz Messtechnik GmbH according below schedule. During this procedure the slip rings will be tested and the sensor will be re-calibrated. In order to avoid measuring signal fluctuations, the carbon dust should be removed from the sensor housing (depending on speed). We recommend to clean the sensor as described below five times during the durability of the brushes. Testing of the slip rings at Lorenz Messtechnik GmbH.

| Speed 1/min | Small Size < 35 mm width Revolutions | Medium Size < 45 mm width Revolutions | Large Size < 60 mm width Revolutions | X-Large Size < 120 mm width Revolutions |
|----------------|--|---|--|---|
| 10 | $5 \cdot 10^7$ | $4 \cdot 10^7$ | $3 \cdot 10^7$ | $1,5 \cdot 10^7$ |
| 100 | $2 \cdot 10^7$ | $9 \cdot 10^6$ | $8 \cdot 10^6$ | $4 \cdot 10^6$ |
| 500 | $7 \cdot 10^6$ | $5 \cdot 10^6$ | $3 \cdot 10^6$ | $1,5 \cdot 10^6$ |
| 1000 | $5 \cdot 10^6$ | $3 \cdot 10^6$ | $2 \cdot 10^6$ | - |
| 1500 | $4 \cdot 10^6$ | $2,4 \cdot 10^6$ | - | - |
| 2000 | $3 \cdot 10^6$ | - | - | - |

Course of cleaning:

- Open sensor, loosen the 4 screws and carefully lift off the top with brushes.
- Use fine, longhair brush and remove the carbon dust with dry and oil-free air from the sensor. Afterwards clean the slip rings with a fine cloth or a Q-tip, slightly moistened with spirit.
- Carefully clean brush-unit with brush as well and if necessary blow off dust.
- Reassemble sensor and tighten the 4 screws.
- Test functionality of the sensor after the reassembly.



Caution: Do not bend brushes while cleaning!



Open the slip ring sensor

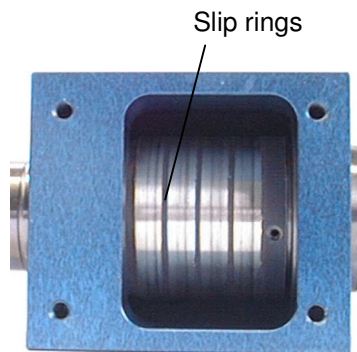

View in sensor on slip rings

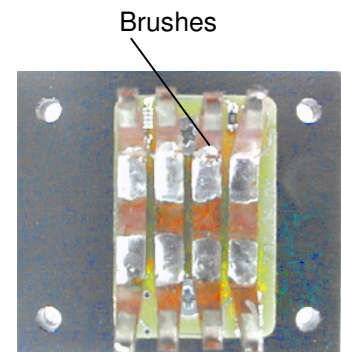

View on carbon brushes



7.2 Trouble Shooting

This chart is used for searching for the most frequent errors and their elimination

| Problem | Possible Cause | Trouble Shooting |
|---------------------------------|---|---|
| No signal | No sensor excitation | <ul style="list-style-type: none"> • Outside of permissible range • Connect excitation • Cable defect • No mains supply |
| | Signal output connected wrong | <ul style="list-style-type: none"> • Connect output correctly • Evaluation electronics defect |
| Sensor does not react to torque | Shaft not clamped | <ul style="list-style-type: none"> • Clamp correctly |
| | No power supply | <ul style="list-style-type: none"> • Outside of permissible range • Connect supply • Cable defect • No mains supply |
| | Cable defect | <ul style="list-style-type: none"> • Repair cable |
| | Connector connected wrong | <ul style="list-style-type: none"> • Connect correctly |
| Signal has dropouts | Axial position rotor to stator outside of tolerance | <ul style="list-style-type: none"> • Align rotor |
| | Cable defect | <ul style="list-style-type: none"> • Repair cable |
| Zero point outside of tolerance | Cable defect | <ul style="list-style-type: none"> • Repair cable |
| | Shaft mounted distorted | <ul style="list-style-type: none"> • Mount correctly |
| | Distorted shaft string | <ul style="list-style-type: none"> • Release from distortion |
| | Strong lateral forces | <ul style="list-style-type: none"> • Reduce lateral forces |
| | Distorted flanges | <ul style="list-style-type: none"> • Check evenness of flange-surfaces |
| | Shaft overloaded | <ul style="list-style-type: none"> • Send to manufacturer |
| Wrong torque indication | Calibration not correct | <ul style="list-style-type: none"> • Re-calibrate |
| | Sensor defect | <ul style="list-style-type: none"> • Repair by manufacturer |
| | Torque shunt | <ul style="list-style-type: none"> • Eliminate shunt |
| Shaft drags | Shaft drags in the rotor | <ul style="list-style-type: none"> • Align shaft • Concentricity of the parts is not ensured |
| | Lateral forces too large | <ul style="list-style-type: none"> • Decrease lateral forces |
| Oscillations | Alignment of shaft not correct | <ul style="list-style-type: none"> • Align correctly |
| | Unbalance | <ul style="list-style-type: none"> • Balance the corresponding parts |

8 Decommission

All sensors must be dismantled professionally. Do not strike sensor housings with tools. Do not apply bending moments on the sensor, e.g. through levers. The torque sensor must be supported to avoid falling down during the dismantling.

9 Transportation and Storage

The transportation of the sensors must occur in suitable packing.

For smaller sensors, stable cartons which are well padded are sufficient (e.g., air cushion film, epoxy crisps, paper shavings). The sensor should be tidily packed into film so that no packing material can reach into the sensor (ball bearings).

Larger sensors should be packed in cases.



9.1 Transportation

Only release well packed sensors for transportation. The sensor should not be able to move back and forth in the packing. The sensors must be protected from moisture.

Only use suitable means of transportation.

9.2 Storage

The storage of the sensors must occur in dry, dust-free rooms, only. Slightly lubricate shafts and flanges with oil before storing (rust).

10 Disposal

The torque sensors must be disposed according to the valid provisions of law. For this, see our "General Terms and Conditions" www.lorenz-sensors.com

11 Calibration

At the time of delivery, torque sensors have been adjusted and tested with traceable calibrated measuring equipment at factory side. Optionally, a calibration of the sensors can be carried out.

11.1 Proprietary Calibration

Acquisition of measurement points and issuing of a calibration protocol Traceable calibrated measuring equipment is being used for the calibration. The sensor data are being checked during this calibration.

11.2 DKD-Calibration

The calibration of the sensor is carried out according to the guidelines of the DKD. The surveillance of the calibrating-laboratory takes place by the DKD. At this calibration, the uncertainty of measurement of the torque measuring instrument is determined. Further information can be obtained from Lorenz Messtechnik GmbH.

11.3 Re-Calibration

The recalibration of the torque sensor should be carried out after 26 months at the latest. Shorter intervals are appropriate:

- Overload of the sensor
- After repair
- After inappropriate handling
- Demand of high-quality standards
- Special traceability requirements

12 Data Sheet

See www.lorenz-sensors.com

13 Literature

Dubbel, Taschenbuch für den Maschinenbau, Springer Verlag