

# 3DM-GX5-45

GNSS-Aided Inertial Navigation System (GNSS/INS)

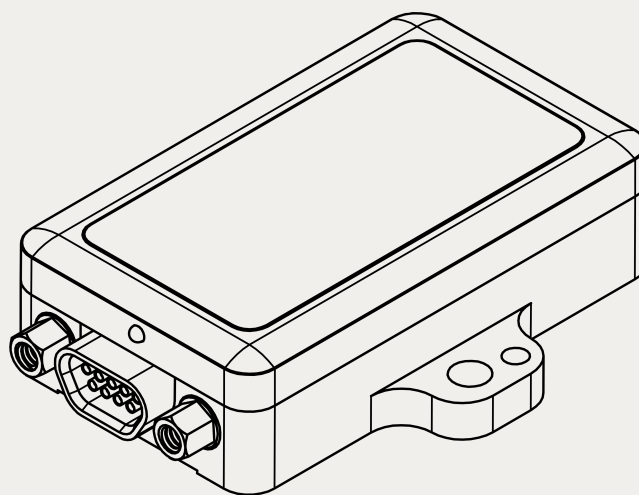



MicroStrain® Sensing Systems  
459 Hurricane Lane  
Suite 102  
Williston, VT 05495  
United States of America

Phone: 802-862-6629

[www.microstrain.com](http://www.microstrain.com)  
[sensing\\_support@LORD.com](mailto:sensing_support@LORD.com)  
[sensing\\_sales@LORD.com](mailto:sensing_sales@LORD.com)

Copyright © 2016 LORD Corporation

3DM®, 3DM-DH®, 3DM-DH3™, 3DM-GX1®, 3DM-GX2®, 3DM-GX3®, 3DM-GX4-15™, 3DM-GX4-25™, 3DM-GX4-45™, 3DM-GX4™, 3DM-GX5™ 3DM-RQ1™, 3DM-GQ4™, AIFP®, Ask Us How™, Bolt-Link®, DEMOD-DC®, DVRT®, DVRT-Link™, EH-Link®, EmbedSense®, ENV-Link™, FAS-A®, G-Link®, G-Link2™, HS-Link®, IEPE-Link™, Inertia-Link®, Little Sensors, Big Ideas.®, Live Connect™, LXRS®, MathEngine®, MicroStrain®, MVEH™, MXRS®, Node Commander®, PVEH™, RHT-Link®, RTD-Link™, SensorCloud™, SG-Link®, Shock-Link™, Strain Wizard®, TC-Link®, Torque-Link™, V-Link®, Watt-Link™, Wireless Simplicity, Hardwired Reliability™, and WSDA® are trademarks of LORD Corporation.

Document 8500-0010 Revision A

Subject to change without notice.

# Table of Contents

---

<b>1. System Overview</b> .....	<b>7</b>
<b>2. Sensor Overview</b> .....	<b>8</b>
3.1 Components .....	9
3.2 Interface and Indicators .....	10
<b>4. Basic Setup and Operations</b> .....	<b>11</b>
4.1 Software Installation .....	12
4.2 System Connections .....	13
4.3 Software Interface .....	13
4.3.1 <i>Interactive Help Menu</i> .....	14
4.4 Sensor Communication .....	15
4.5 GNSS Satellite Link .....	16
4.7 Sensor Settings .....	16
4.7.1 <i>Saving Configurations</i> .....	17
4.8 Data Monitoring and Recording .....	18
4.9 View Recorded Data .....	21
<b>5. Sensor Measurements</b> .....	<b>22</b>
5.1 Direct Sensor Measurements (IMU Outputs) .....	23
5.2 Global Navigation Satellite System (GNSS) Outputs .....	25
5.3 Computed Outputs (Estimation Filter) .....	27
5.4 Sensor Reference Frames .....	30
5.4.1 <i>Geodetic Frame</i> .....	30
5.4.2 <i>North East Down (NED) Frame</i> .....	30
5.4.3 <i>Sensor Frame</i> .....	32
5.4.4 <i>Platform Frame</i> .....	32
<b>6. Performance Optimization</b> .....	<b>35</b>

---

6.1 Gyroscope Bias .....	35
<b>6. Tare Orientation .....</b>	<b>36</b>
6.2 Tare Mounting Pitch-Roll .....	36
6.3 Magnetometer Auto Calibration .....	37
6.3.1 Enable .....	37
6.3.2 Capture .....	38
6.4 Manual Magnetometer Calibration .....	39
6.5 Estimation Filter Aiding .....	42
6.6 Heading Aiding Settings .....	43
6.7 Vehicle Dynamics Mode .....	44
6.8 Adaptive Anomaly Rejection .....	45
6.8.1 Gravity Adaptive .....	45
6.8.2 Mag Adaptive .....	46
6.9 Angular Rate and Acceleration Limits .....	47
6.10 Communications Bandwidth .....	47
6.11 Platform Frame Transformation .....	47
6.12 GNSS Parameters .....	47
6.13 GNSS Antenna Offset .....	48
6.14 Estimation Filter Operation .....	49
6.15 Estimation Filter Convergence .....	51
6.15.1 Initial Convergence .....	51
6.15.2 Bias Convergence .....	51
6.15.3 Output Uncertainty .....	51
6.16 Vibration Isolation .....	52
6.17 IMU Sensor Calibration .....	52
6.18 Temperature Compensation .....	52
6.19 Import and Export Settings .....	53

---

<b>7. Sensor Installation</b>	<b>54</b>
7.1 Sensor Mounting	54
7.2 GNSS Antenna Installation	55
<b>8. OEM System Integration</b>	<b>56</b>
8.1 Data Communications Protocol (DCP)	56
8.1.1 Packet Builder	57
8.1.2 Sensor Direct Mode	58
8.1.3 GNSS Direct Mode	59
8.2 Sensor Wiring	60
8.3 Alternate GNSS Equipment	61
8.3.1 GNSS External Receiver	62
8.4 Sampling on Start-up	63
8.5 Connecting to a Datalogger	64
8.6 Using Wireless Adapters	64
<b>9. Troubleshooting</b>	<b>65</b>
9.1 Troubleshooting Guide	65
9.2 Repair and Calibration	69
9.3 Technical Support	70
<b>10. Maintenance</b>	<b>71</b>
<b>11. Parts and Configurations</b>	<b>72</b>
11.1 Standard Configurations	72
11.2 Accessories	74
11.3 Sales Support	75
<b>12. Specifications</b>	<b>76</b>
12.0.1 Geodetic Frame	80
<b>13. Safety Information</b>	<b>81</b>
13.1 Disposal and Recycling	81

---

<b>14. Addendum</b> .....	<b>82</b>
14.1 Reference Diagrams .....	82
14.1.1 <i>Sensor Dimensions and Origin</i> .....	82
14.1.2 <i>GNSS Antenna Specifications</i> .....	83
14.1.3 <i>Power Supply Specifications (RS232 kits only)</i> .....	84
14.1.4 <i>Communication and Power Cables</i> .....	85
14.2 Reference Documents .....	87
14.3 Glossary .....	88

## 1. System Overview

The LORD Sensing 3DM-GX5 family of industrial grade inertial sensors provides a wide range of triaxial inertial measurements and computed attitude and navigation solutions.

In all models, the Inertial Measurement Unit (IMU) includes direct measurement of acceleration and angular rate, and some also offer atmospheric pressure readings. Sensor measurements are processed through an Extended Kalman Filter (EKF) to produce highly accurate computed outputs. The 3DM-GX5 features include extremely stable and low-noise gyros, a new accelerometer with noise densities as low as  $25 \mu\text{g}/\sqrt{\text{Hz}}$ , and a multi-constellation GNSS receiver. The M7 and M4 dual Cortex processors run a new Auto-Adaptive EKF. The Kalman filter enables compensation for magnetic and linear acceleration anomalies as applicable to the model. It also provides sensor bias tracking, auto-zero update options (ZUPT), and user adjustable sensor noise factors. All sensors are fully temperature compensated and calibrated over the full operating temperature range.

The use of Micro-Electro-Mechanical System (MEMS) technology allows for small, lightweight devices. Sensors are integrated into customer systems using serial communication protocols such as RS422, RS232 and USB. The LORD Sensing MIP Monitor software can be used for device configuration, real time measurement monitoring, and data recording. The LORD Sensing MIP Data Communications Protocol that is used to communicate with LORD Sensing inertial sensors is also available for users who want to develop customized software solutions. Because of the unified set of commands across the sensor family, it is easy to migrate code from one inertial sensor to another.

Common applications of LORD Sensing inertial sensor products include vehicle health monitoring, platform stabilization, down-hole and drilling operations, and inertial navigation systems such as unmanned air and ground vehicles and personal navigation systems.

GNSS-Aided Navigation  
System



GNSS/INS

Attitude/Heading Reference  
System



AHRS

Inertial Measurement Unit



IMU/VRU

Downhole Sensors



DH

## 2. Sensor Overview

The 3DM-GX5-45 is a high-performance, GNSS-Aided Inertial Navigation System (GNSS/INS) that combines micro inertial sensors and a high-sensitivity embedded Global Navigation Satellite System (GNSS) receiver for use in a wide range of industrial grade applications, such as unmanned vehicle navigation, robotic control, platform stabilization, motion tracking and analysis, vehicle health monitoring, and device aiming.

The 3DM-GX5-45 utilizes the strengths of an integrated multi-axis gyroscope, accelerometer, and magnetometer in combination with GNSS, temperature, and pressure readings to provide highly accurate position, velocity, attitude (including heading), and inertial measurements. Each of the integrated sensors is especially good at certain tasks, and it is the weighted combination of their outputs that provides the best estimations for position, velocity, and attitude. All sensor measurements are temperature compensated and are mathematically aligned to an orthogonal coordinate system. The combination of sensors, environmental compensation, and dual on-board processing with an Extended Kalman Filter (EKF) allows the 3DM-GX5-45 to perform well in a wide variety of applications that require low noise, drift, gain, and offset errors. Uncertainty monitoring, scale factor estimation, and bias estimation outputs are available, and settings for sensor filtering, sensor noise, sensor bias, and more offer many adjustments for specific application needs.

The 3DM-GX5-45 communicates through a serial connection and is monitored by a host computer. A detachable GNSS antenna is plugged into the sensor via a non-magnetic adapter cable and connector and positioned with unobstructed line of sight to the sky to obtain satellite links. Sensor measurements and computed outputs can be viewed and recorded with the LORD Sensing MIP Monitor software that is provided with system connectivity kits. It is also available as a free download from the LORD Sensing website. Alternatively, users can write custom software with the LORD Sensing open source data communication protocol. The data is time-aligned and available by either polling or continuous stream.

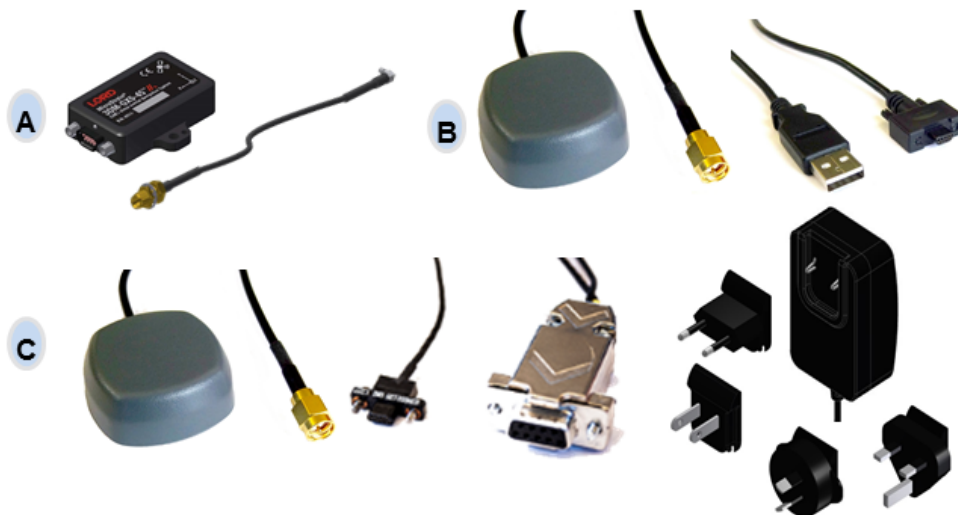

Figure 1 - 3DM-GX5-45 Sensor



### 3.1 Components

The 3DM-GX5-45 Inertial Sensor can be purchased by itself or with a Connectivity Kit. All software, drivers, and links to detailed documentation are included with the sensor purchase. For a complete list of available configurations, accessories, additional system products, and ordering information, [See Parts and Configurations on page 72](#)



Item	Description	Quantity	Model	LORD Sensing Part Number
<b>Included with Sensor Purchase</b>				
A	3DM-GX5-45 Inertial Sensor GNSS Non-Magnetic Antenna Adapter Cable	1	GNSS/INS 8G, 300 DPS*	6251-4220
	MIP Monitor Software Suite	<a href="http://www.microstrain.com/software">http://www.microstrain.com/software</a>		
	* For additional options available, <a href="#">See Specifications on page 76</a>			
<b>USB Connectivity Kit</b>				
B	GNSS Antenna with Attached Cable (3m SMA)	1	--	6212-3002
	USB Communication Cable	1		
<b>RS232 Connectivity Kit</b>				
C	GNSS Antenna with Attached Cable (3m SMA)	1	--	6212-3002
	RS232 Communication Cable	1		
	RS232 Power Supply and Plug Adapters	1		

Table 1 - 3DM-GX5-45 Components

### 3.2 Interface and Indicators

The 3DM-GX5-45 sensor interface includes a communications and power input connector and a GNSS antenna port. The sensor is installed using the mounting and alignment holes as needed ([see Sensor Mounting on page 54](#)).

The indicators on the 3DM-GX5-45 include a device status indicator and the device information label. [Table 2 - Indicator Behaviors](#) describes the basic status indicator behavior. The device information label includes the sensor frame diagram (axis orientation), which will be critical during device installation ([see Sensor Frame on page 32](#)).

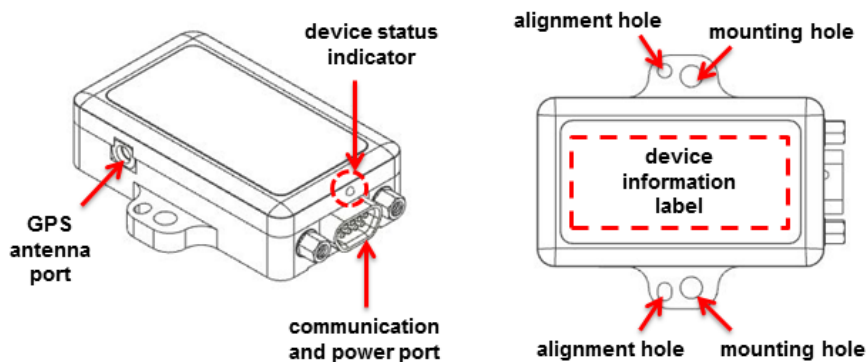

Figure 2 - Interface and Indicators

Indicator	Behavior	Device Status
device status indicator	OFF	no power applied
	rapid flash	streaming data with no GNSS lock
	steady blink	streaming data with GNSS lock
	slow pulse	idle mode, awaiting commands

Table 2 - Indicator Behaviors

## 4. Basic Setup and Operations

### NOTICE

Do not put the 3DM-GX5-45 in contact with, or in close proximity to, magnets. Magnets may disrupt operation and cause magnetization of internal components, which can affect magnetometer performance. If magnetization is suspected, use a degaussing tool to demagnetize.

To acquire sensor measurements and computed outputs, the 3DM-GX5-45 uses a host computer, a communications port, and applicable software. The LORD Sensing MIP Monitor software is provided with the system and includes all functions needed for sensor configuration and data acquisition. Users may also utilize the LORD Sensing MIP Data Communications Protocol to write custom software applications with expanded or specific feature sets needed for the application. MIP Monitor includes a message building tool that can be used to streamline this process. For more information [see OEM System Integration on page 56.](#))

In this section hardware and software setup is described, including an overview of the MIP Monitor software menus required to configure a sensor and begin data acquisition. This is not a complete demonstration of all system or software features and capabilities.

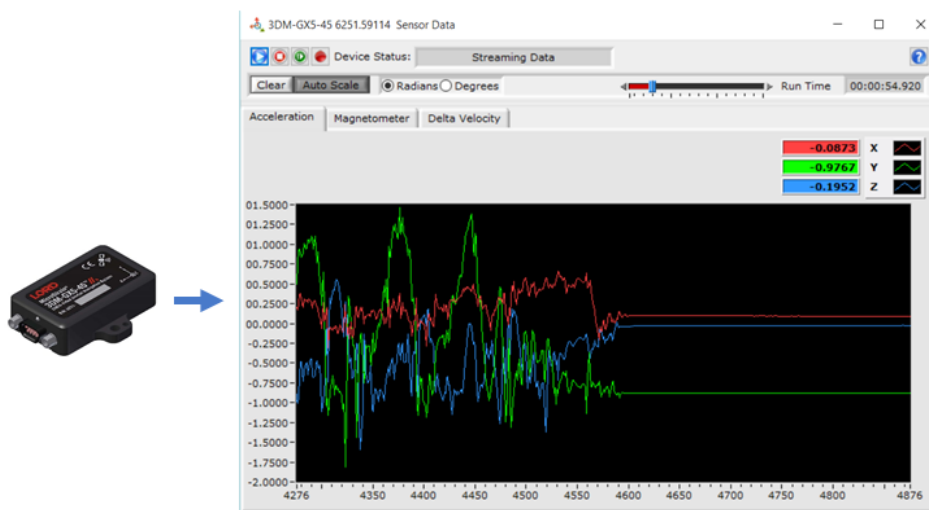

Figure 3 - Viewing Sensor Data with MIP Monitor

## 4.1 Software Installation

### NOTE

The MIP Monitor Software Suite includes hardware drivers required for 3DM-GX5-45 sensor operation. Sensors will not be recognized without these drivers installed.

To Install the MIP Monitor software on the host computer, complete the following steps:

1. Launch the MIP Monitor software installation menu at:  
<https://www.microstrain.com/software>.
2. Download and open the MIP Monitor zip file.
3. Run the **setup.exe** file, and follow the on-screen prompts to completion.
4. Download and open the Inertial Drivers zip folder to install the hardware drivers required for operating the sensor.
5. Run the **msi** file, and follow the on-screen prompts to completion.
6. If the sensor has internal magnetometers, download and open the Iron Calibration zip file to facilitate magnetometer field calibration.
7. Run the **setup.exe** file, and follow the on-screen prompts to completion. If prompted, reboot the computer when complete.

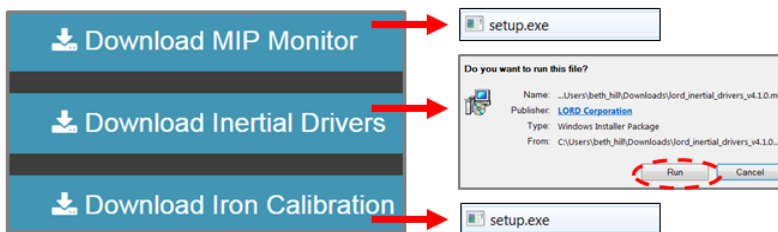

Figure 4 - Software Installation Menu

## 4.2 System Connections

### **CAUTION**

Power is applied to the sensor through an external power supply, such as the one provided in the starter kit. Use only power supplies within the operating range of the sensor, or damage or injury could result. Once power is applied the sensor is on and active ([see Specifications on page 76](#)).

To acquire sensor data the following components are needed: 3DM-GX5-45 sensor, communication cable, power cable (as applicable for RS232 communications), GNSS antenna, GNSS non-magnetic antenna adapter cable, and a host computer with LORD Sensing MIP Monitor installed.

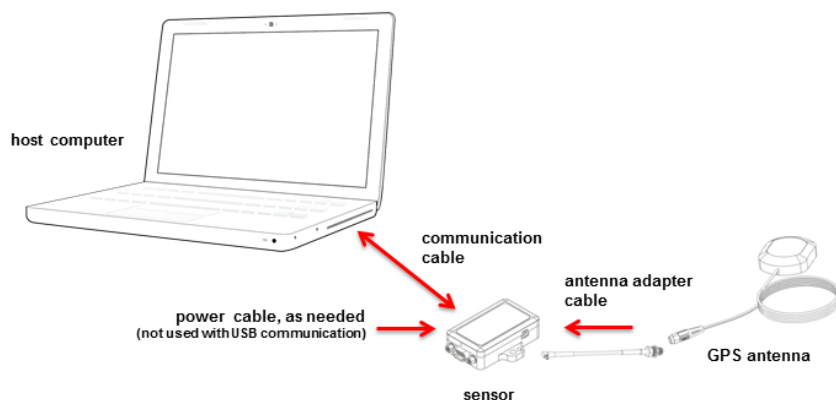

Figure 5 - System Connections

## 4.3 Software Interface

The MIP Monitor software includes a main window with system information and menus, a device settings window ([see Sensor Settings on page 16](#)), and several data monitoring windows ([see Data Monitoring and Recording on page 18](#)).

The main window provides an overview of connected devices. Devices are selected by clicking on them. A device menu is available by right-clicking on the device name and includes the most used items from the header row menus ([Figure 6 - Main Window](#)). The header row menu includes selections for data sampling, recording, device settings, opening windows, selecting which open window to view, and advanced features such as selecting the communications mode. The icon toolbar includes buttons for Help Menu access, where all related documentation is available in Web Resources, device refresh, and data sampling and recording ([see Data Monitoring and Recording on page 18](#)).

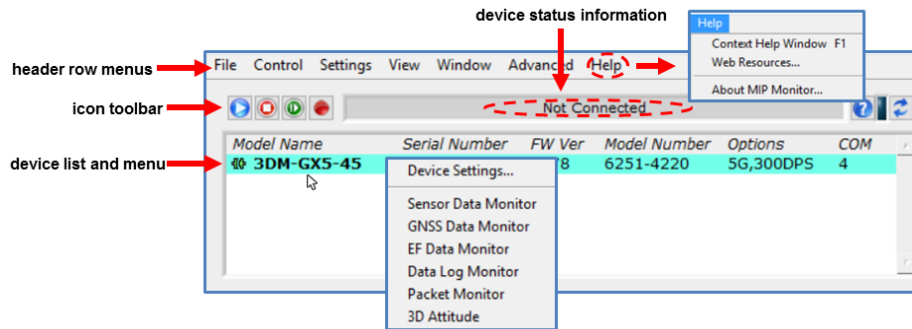

Figure 6 - Main Window

### 4.3.1 Interactive Help Menu

MIP Monitor also includes a mouse-over feature that provides explanations of the information and settings. This feature is enabled by selecting the question mark icon or Help button in any window.

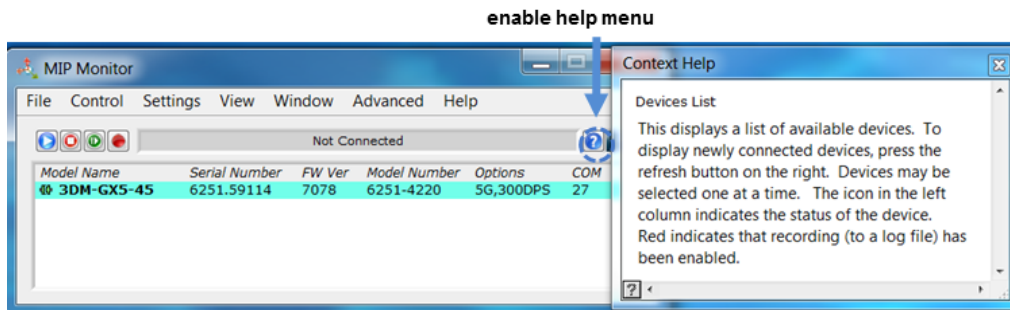

Figure 7 - Context Sensitive Help Menu

## 4.4 Sensor Communication

Once power has been applied to the sensor, it is functional. The sensor selects the appropriate serial communication (USB or RS232) on power-up based on which cable is connected. If the hardware drivers have been installed, communication can be established using the MIP Monitor software interface. GNSS lock is not required to establish sensor communication.

1. Verify the sensor device status indicator is on.
2. Open the MIP Monitor software.



3. The sensor should appear in the device list automatically when the software is running. The list includes the device information and communication port assignment. If the sensor is not automatically discovered, use the refresh button.

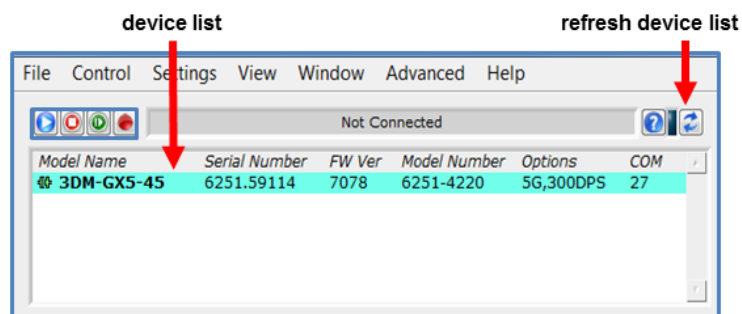

Figure 8 - Sensor Communication

### NOTE

If data is not actively being exchanged between the sensor and host computer, the status message may display Not Connected. This indicates the port status, not the sensor availability. When commands are sent to the sensor, the software will automatically connect to it before sending the message.

## 4.5 GNSS Satellite Link

### 6. Connect to GNSS Satellites

#### NOTE

The GNSS antenna requires unobstructed line of sight with the sky in order to achieve communication with the GNSS satellites.

Communication between the GNSS receiver and GNSS satellites is initiated when the 3DM-GX5-45 is first powered on. The receiver will continuously search for satellites until a link is established. When the link is established, the GNSS Monitor window in the MIP Monitor software will display the satellite and link statistics ([see Global Navigation Satellite System \(GNSS\) Outputs on page 25](#)).

Communication with the satellites is required for proper sensor operation, although some measurement outputs will be available without it.

## 4.7 Sensor Settings

Device settings are stored in the sensor memory. Only the configuration options that are available for the type of sensor being used will be available in the configuration menus.

1. To enter the settings menu, right-click on the sensor name, and select Device Settings:
1. **Main menu tabs:** The main tabs break up the setting into broad functional groups for the types of measurement available. For the 3DM-GX5-45 these include calculated measurements (Estimation Filter), GNSS metrics and direct inertial sensor measurements (IMU/AHRS).
2. **Message Format (first sub-menu tab):** Under each main menu tab there are additional sub-menu tabs, including the Message Format tab. The Message Format tab allows the user to select the measurement type to be displayed and recorded (b1) and the data rate (rate at which data is sent to the host computer) in samples/second (b2).
3. **Measurement parameters (other sub-menu tabs):** Available sub-menu tabs besides the Message Format tab depend on the selected main menu tab. These tabs include the configurable settings for each measurement. GNSS
4. **Scrolling:** used to navigate to additional sub-menus
5. **Help button:** Enable the context-sensitive help menu for explanations of specific settings ([see Interactive Help Menu on page 14](#)).



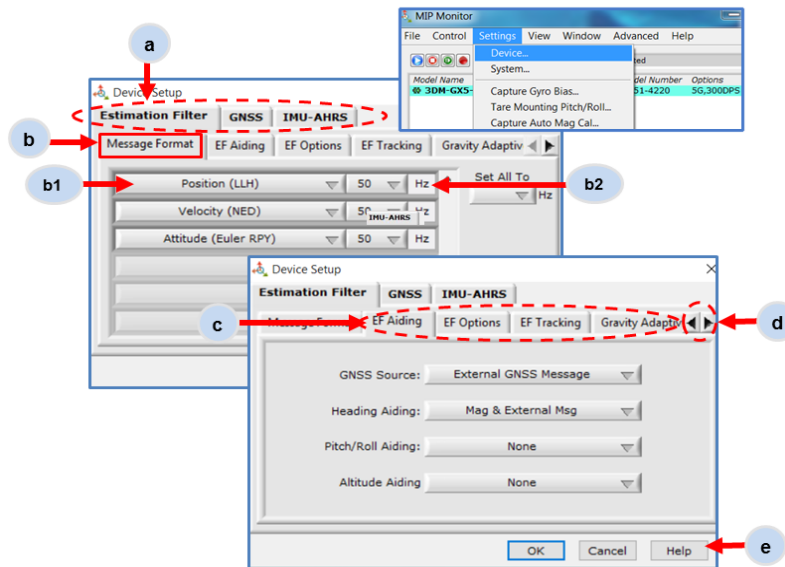

Figure 9 - Device Settings Menu

#### 4.7.1 Saving Configurations

Sensor settings are saved temporarily by selecting the OK button in the Device Setup window after configuration, but they are lost when the device is powered off. To save current settings so they are automatically restored the next time the device is powered on, select Settings > Save Current Settings.

First adjust the sensor settings to the desired values. Next select Settings > Save Current Settings from the main window ([Figure 10 - Save Sensor Settings](#)). The setting will now remain intact when the sensor is powered off and then on again.

To recall the last saved settings select Settings > Load Startup Settings. To revert the settings back to the factory defaults, select Settings > Load Default Settings.

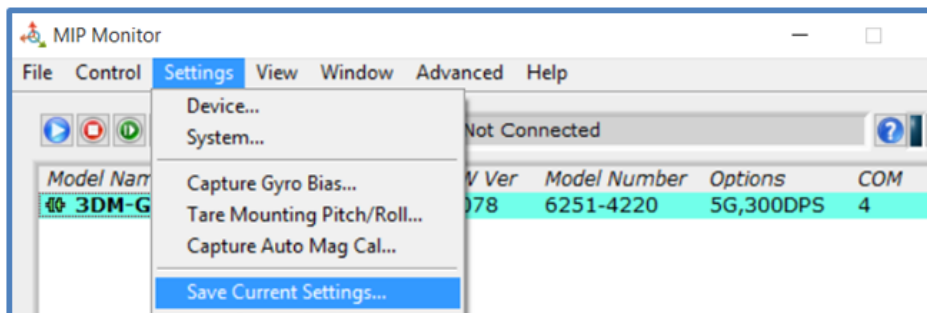

Figure 10 - Save Sensor Settings

## 4.8 Data Monitoring and Recording

Throughout the MIP Monitor menus the same icons are used to control data streaming (sampling) and recording. These icons can be found in the MIP Monitor main window icon toolbar and in each data monitoring window. The same commands are also found in the main window Control menu.

sampling and recording controls  
(main window)

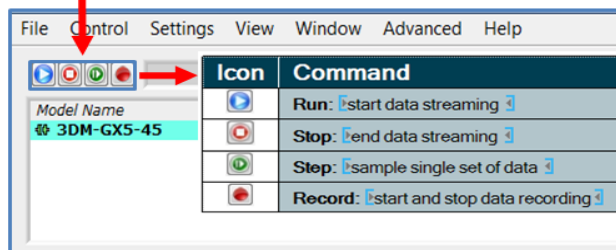

Figure 11 - Sampling and Recording Controls

There are several data monitoring views available depending on what measurements are desired for monitoring and recording. Each view corresponds to one of the main categories in the Device Settings window. For example, the 3DM-GX5-45 includes Sensor Data Monitoring for the IMU/AHRS measurements, GNSS Monitoring for the GNSS metrics, and EF Monitoring for the Estimation Filter outputs ([Figure 12 - Data Streaming](#)). During viewing and recording only the outputs that are selected in the Message Format tab of the Device Settings menu are displayed and recorded ([see Sensor Settings on page 16](#)).

Data streaming must be started in order for data to be recorded, however it is not necessary to view it in a data monitoring window. Data monitoring is used primarily to confirm the system is operating correctly or to view the outputs in near real time. If sensor setup has already been confirmed, streaming and recording can be initiated from the main window.

*Figure 12 - Data Streaming* is an example of Sensor Data Monitoring, which displays the selected IMU/AHRS measurements. In data monitoring windows, no data will be displayed until data streaming is started, and no data will be recorded (even if it is being viewed) until data recording is initiated (armed). In the example below, the y-axis of the graph indicates data points, the x-axis is the measurement units, and there is a tab for each measurement.

1. Right-click on the device in the MIP Monitor software main window, and select Sensor Data Monitoring.
2. Press the blue Start Streaming icon to start sampling.

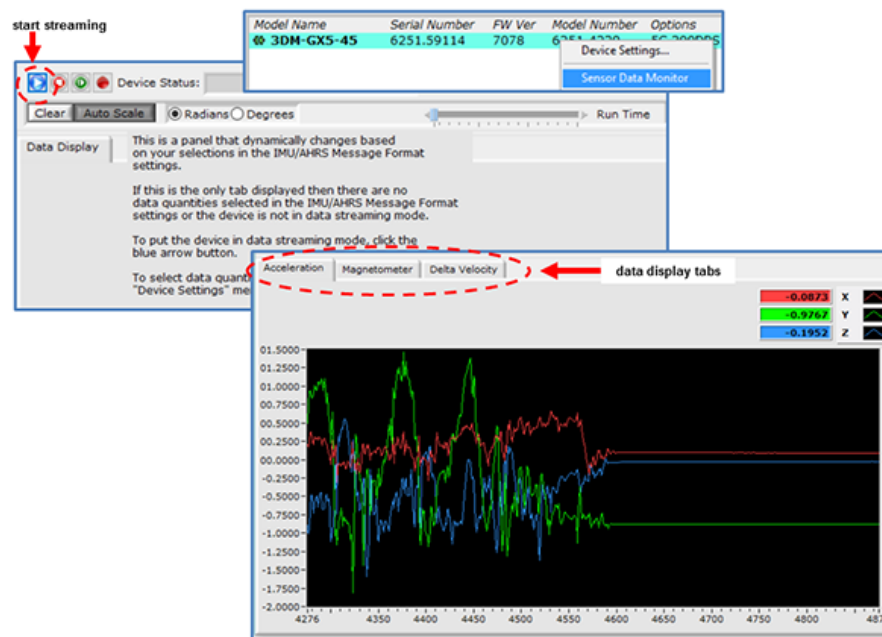
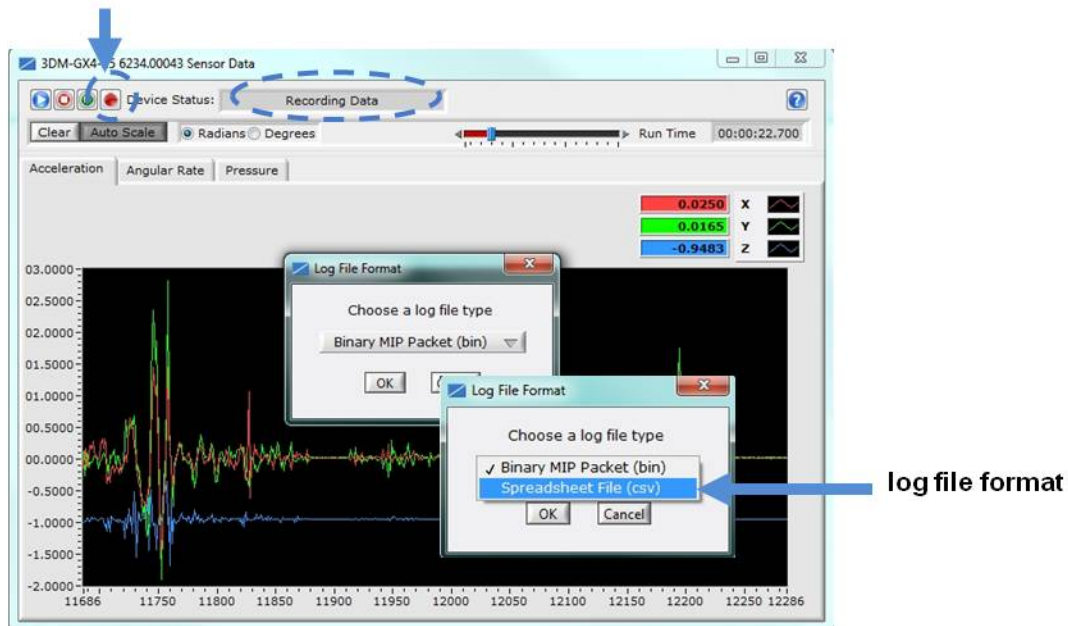

**Figure 12 - Data Streaming**

3. To record data, select the Arm Recording icon at any time.
4. Select the type of data file to generate: Binary or CSV. The CSV file is the most common and can be viewed and processed by data editors such as Microsoft Excel®.
5. To save a settings file when creating a data file, check the box next to this option. This settings file is the same as selecting Export Settings from the Settings menu.

**NOTE**

If the data is recorded in Binary format it will require a translation program that utilizes the LORD Sensing MIP Data Communications Protocol to make it user-readable.

**arm data recording**

**Figure 13 - Data Recording**

6. To end recording press the Arm Recording button again, and select OK in the confirmation prompt window.
7. Select the Stop Streaming icon to end sampling.
8. Use the red "X" in the upper right of the sensor monitoring window to exit monitoring mode.

## 4.9 View Recorded Data

Recorded data is stored in either Binary (.bin) or Comma Separated Values (.CSV) format, depending on what was selected at the initiation of data recording. The files can be found in the directory specified at that time or in the default directory on the host computer desktop.

CSV files can be viewed with Microsoft Excel, Quattro Pro, Open Office, or other CSV editors and spreadsheet programs.

Data recorded in Binary format requires a translation program utilizing the LORD Sensing MIP Data Communications Protocol to make it user-readable.

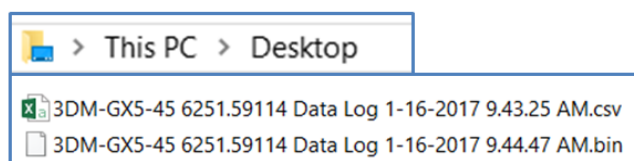

### NOTE

Data in the data files is displayed in time sequence. If measurements are set to different data rates, not all time intervals will include a reading from each output that is being recorded.

## 5. Sensor Measurements

The 3DM-GX5-45 block diagram (*Figure 14 - 3DM-GX5-45 Block Diagram*) describes its primary hardware components and internal configuration. Integrated Micro-Electro-Mechanical System (MEMS) sensors within the 3DM-GX5-45 are collectively known as the Inertial Measurement Unit (IMU) and include tri-axial gyroscopes (gyros), tri-axial accelerometers, tri-axial magnetometers, and a pressure altimeter. This technology provides direct measurements of acceleration, angular rate, magnetic field, pressure, delta-Theta (change in angular rate), and delta-v (change in velocity). Temperature and pressure sensors provide environmental information for measurement compensation and altitude estimations. GNSS

Computed estimations for position, velocity, and attitude (PVA) are available outputs on the 3DM-GX5-45. To achieve these estimations, the MEMS sensors and GNSS solution are blended together in a loosely-coupled Extended Kalman Filter on a dedicated filter processor. Additional user settings such as measurement filtering, biasing, and tolerance values offer adjustments for specific applications.

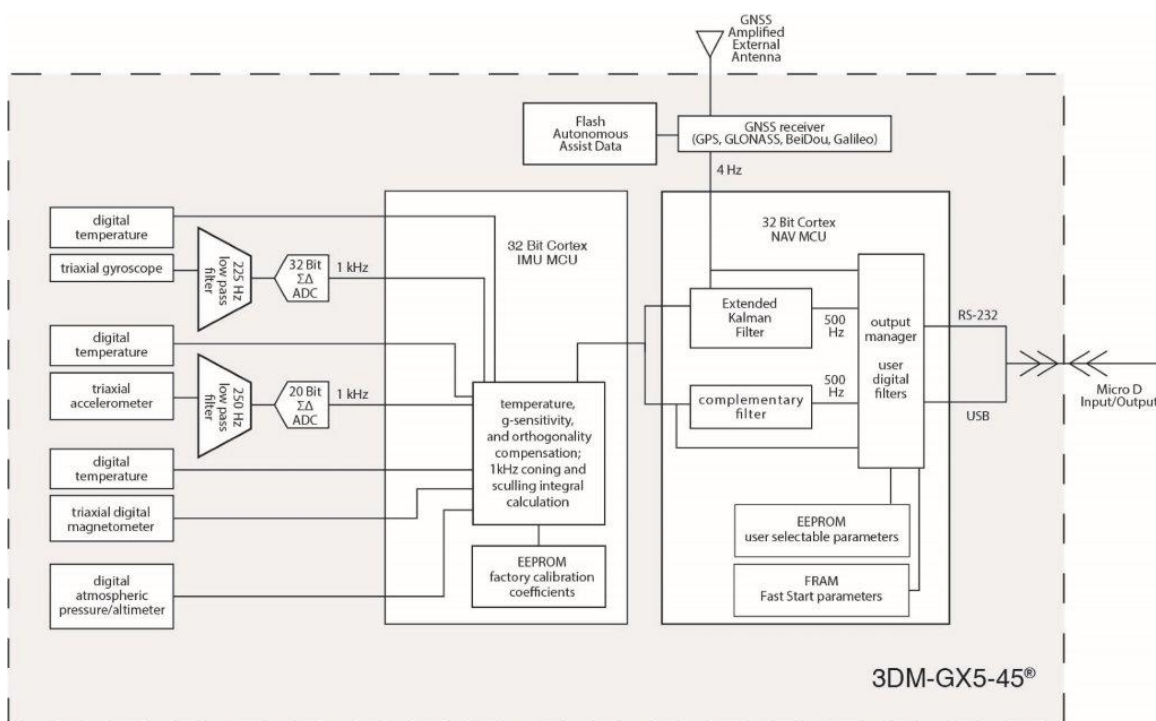

Figure 14 - 3DM-GX5-45 Block Diagram

## 5.1 Direct Sensor Measurements (IMU Outputs)

The sensors in an Inertial Navigation System (INS), from which measurements for navigation and orientation are obtained, are collectively known as the Inertial Measurement Unit (IMU). These sensors are arranged on the three primary axes (x, y, and z) to sense angular rate, acceleration, and the local magnetic field. The gyroscopes are used to adjust the current attitude estimate when an angular rate is sensed. The accelerometers sense gravity as well as linear acceleration. The magnetometers sense the Earth's magnetic field along with local magnetic anomalies. All measurements are temperature-compensated and are mathematically aligned to an orthogonal coordinate system.

The IMU sensors can be read directly to report stand alone inertial measurements or computed measurements. Because the sensor system is digital, the analog voltage readings from the sensors are converted into a digital equivalent value based on the volt-to-bit scale of the internal analog-to-digital voltage converter. In the MIP Monitor software the conversion values are not configurable, but there are user-settable options for how the measurement is made. These settings are available at: Settings > Device > IMU (tab). With the Help window open (accessed with the Help button), mousing over context-sensitive settings provides a detailed explanation of the setting (*Figure 15 - IMU Settings*).

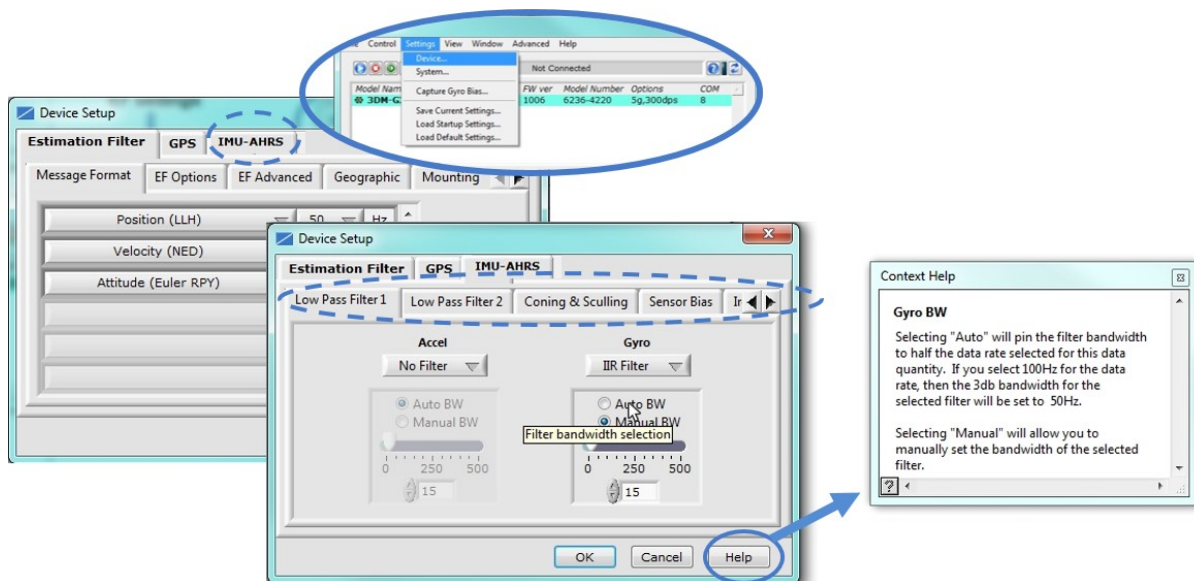

Figure 15 - IMU Settings

*Table 3 - IMU Measurements* lists the IMU measurements available for the 3DM-GX5-45. Additional measurement units may be available in MIP Monitor for some outputs, however they are converted values and do not represent the actual sensor outputs. Only actual output units are listed.

The Complementary Filter (CF) attitude, and up and north vector outputs are computed estimations from the LORD Sensing 3DM-GX3<sup>®</sup> inertial sensor family and are available to maintain backwards

compatibility. For new applications it is recommended that these estimations be computed with the 3DM-GX5-45 EF Outputs algorithms (*see Computed Outputs (Estimation Filter) on page 27*).

To view and record IMU outputs, *see Basic Setup and Operations on page 11*.

Measurement	Units	Description
Acceleration	gravitational force (g)	three axis acceleration readings in engineering units
Magnetic Field	Gauss (G)	three axis magnetic field readings in engineering units
Angular Rate	radian/second	three axis rotational velocity reading from gyroscope in engineering units
Delta Angle (Theta)	radians	time integral of angular rate with configurable time period
Delta Velocity	g*seconds	time integral of acceleration with configurable time period
GPS Correlation Timestamp	weeks, seconds, and status indicators	time metrics from the receiver for tracking IMU sensor data
Ambient Pressure	millibars	air pressure reading from pressure sensor
CF Attitude (Euler RPY)	radians	Complementary Filter (CF) Euler angles representation of orientation
CF Attitude (Matrix)	--	Complementary Filter (CF) matrix representation of orientation
CF Attitude (Quaternion)	--	Complementary Filter (CF) quaternions representation of orientation
CF North Vector	--	Complementary Filter (CF) north vector
CF Up Vector	--	Complementary Filter (CF) up vector

**Table 3 - IMU Measurements**



## 5.2 Global Navigation Satellite System (GNSS) Outputs

The Global Navigation Satellite System (GNSS) receiver in the 3DM-GX5-45 uses its own GNSS positioning engine to calculate a position, velocity, and time solution, and it requires a minimum of four satellites. Accuracy and reliability of the GNSS readings are highly dependent on the quality of the satellite fix, and information is provided to determine an appropriate confidence level. External aiding systems, such as Wide Area Augmentation System (WAAS) in the US, help compensate for certain error sources that can affect GNSS accuracy. Position of the antenna is also an important consideration (*see [GNSS Antenna Installation on page 55](#)*).

Readings and information are available directly from the GNSS receiver. *Table 4 - GNSS Outputs* describes the available outputs. GNSS reporting and recording can be enabled in the MIP Monitor software at: Settings > Device > GNSS. There are also user-settable options for how the GNSS satellites are used. The settings are available in the GNSS Tracking and GNSS SBAS tabs. BeiDou and GLONASS cannot be tracked simultaneously, but any other combination is allowed. With the Help window open (accessed with the Help button), mousing over context-sensitive settings provides a detailed explanation of the setting (*Figure 16 - GNSS Settings*).

Enable Assisted Fix retains information about the last good GNSS fix, reducing the TTFF (Time To First Fix) depending on how old the information from the last fix is. For more information, see *GNSS Assisted Fix Control* in the *Data Communications Protocol Manual*.

To view and record GNSS outputs, *see [Basic Setup and Operations on page 11](#)*.

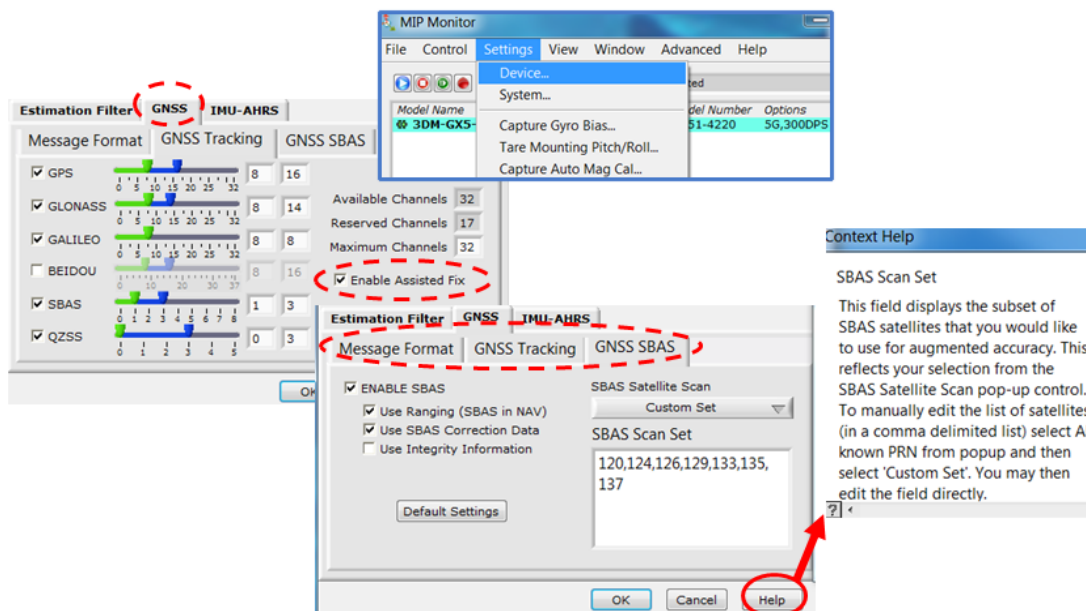

Figure 16 - GNSS Settings

Measurement	Units	Description
Position (LLH)	degrees (latitude, longitude) meters (height, accuracy)	position reported by GNSS module only, expressed in latitude, longitude, and height (LLH) with accuracy estimation. Height is elevation or altitude relative to average sea level (MSL reading) or height relative to WSG-84 Ellipsoid (AE reading).
Velocity (NED)	meters/second (velocity, accuracy)	velocity measurement reported by GNSS module, with reference to the North-East-Down coordinate system and with accuracy estimation
Heading (NED)	degrees	heading reported by GNSS module, with reference to the North, East, Down coordinate system and with accuracy estimation *
Speed	meters/second (speed, accuracy)	speed along direction of travel in 2D and 3D space as reported by GNSS module only *
Position (ECEF)	meters	position reported by GNSS module, with reference to the Earth Centered, Earth Fixed (ECEF) Cartesian coordinate system
Velocity (ECEF)	meters/second (velocity, accuracy)	velocity reported by GNSS module, with reference to the Earth Centered, Earth Fixed (ECEF) Cartesian coordinate system
DOP Data	--	Dilution of Precision (DOP) ratings for accuracy of GNSS readings
GPS Time	weeks & seconds	time acquired from the satellites
UTC Time	time and date	Coordinated Universal Time (UTC) to fractional seconds with leap year seconds adjustment and confidence indicator. Also week number, month, date and year.
Clock Information	seconds	clock accuracy metrics
GNSS Fix Information	--	information about the type, quantity and quality of the satellite connections
Space Vehicle Information (SVI)	N/A	referred to as Satellite Info, includes satellite number and signal strength
Hardware Status	--	operational status of GNSS receiver and antenna
DGPS Information	--	individual satellite signal strength indicator
DGPS Channel Status	--	(future use)

\*Output not available in MIP Monitor. Refer to the 3DM-GX5-45 MIP Data Communications Protocol manual

Table 4 - GNSS Outputs

### 5.3 Computed Outputs (Estimation Filter)

The computed outputs are measurements from the 3DM-GX5-45 IMU sensors and GNSS receiver that are blended through an Extended Kalman Filter (EKF) algorithm. The Kalman Filter produces a better estimation of position, velocity, and attitude (PVA) outputs than can be achieved by the inertial sensors or the GNSS individually. This estimate is output at a higher data rate than GNSS and is not subject to the integration errors inherent in an inertial-only solution. Refer to [Table 5 - Estimation Filter Outputs](#) for a complete list of outputs.

In the MIP Monitor software there are user-settable options for how the estimations are made. These settings are available at: Settings > Device > EF. With the Help window open (accessed with the Help button), mousing over context-sensitive settings provides a detailed explanation of the setting ([Figure 17 - Estimation Filter Settings](#)).

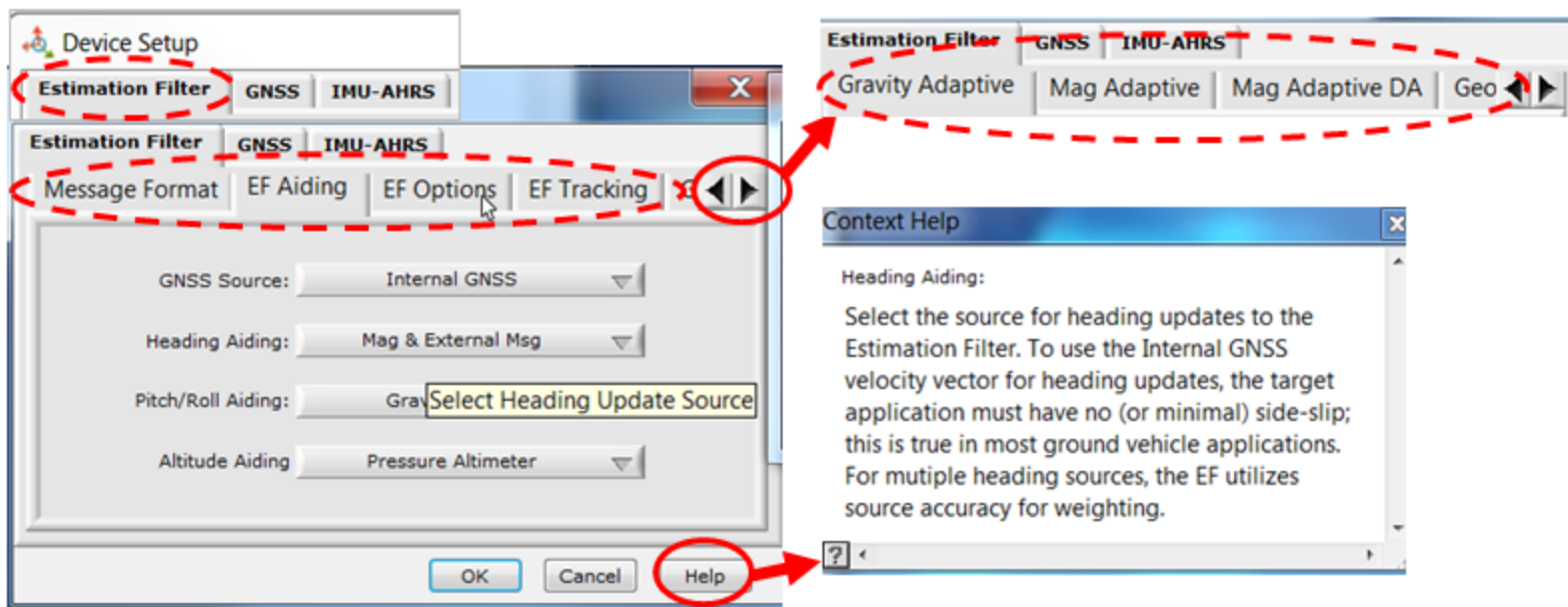

Figure 17 - Estimation Filter Settings

All of the estimation filter outputs are available to record and most, but not all, are available to view in real time in MIP Monitor. In addition to the standard position, velocity, attitude, and time (PVA&T) solution, additional filter outputs, such as uncertainties, inertial sensor bias and scale factors, filter status, and physical models (WGS84, WMM, and SAM) are available ([Table 5 - Estimation Filter Outputs](#)).

To view and record Estimation outputs, ([see Basic Setup and Operations on page 11.](#))

Measurement	Units	Description
Filter Status	--	indicates the current state of the EF, such as running or initializing
GPS Time	weeks & seconds	GNSS time corresponding to the calculated filter solution
Position (LLH)	degrees (position) meters (height, uncertainty)	estimated position based on combined sensors inputs and EF, expressed in latitude, longitude, and height (LLH) with uncertainly estimation available
Velocity (NED)	meters/second (velocity, uncertainty)	estimated velocity based on combined sensor inputs and EF, with reference to the North-East-Down coordinate system and with uncertainty estimation available
Attitude (Euler RPY)	radians	Euler angles representation of orientation expressed as roll, pitch and yaw (RPY) with one-sigma uncertainly estimation available
Attitude (Matrix)	--	transformation matrix that describes orientation with reference to the Earth Centered Earth Fixed (ECEF coordinate system
Attitude (Quaternion)	--	unit quaternions representation of orientation with one-sigma uncertainly estimation available
Acceleration (Linear and Compensated)	meter/second <sup>2</sup>	absolute or linear acceleration readings with reference to either the sensor or vehicle frame (depending on settings), with bias and scale readings, and one-sigma uncertainty estimations also available.
Compensated Angular Rate	radians/second	measured angular rate corrected using the estimated gyroscope scale factor and bias, with reference to either the sensor or vehicle frame (depending on settings)
Gravity Vector	meter/second <sup>2</sup>	estimated WGS84 gravity vector with reference to either the sensor or vehicle frame (depending on settings)
WSG-84 Local Gravity Magnitude	meter/second <sup>2</sup>	local WGS84 gravity vector magnitude
Heading Update	radians	heading used to update EF, calculated from the selected heading source (magnetometer, external, etc.) with one-sigma uncertainty reading available

Measurement	Units	Description
WMM (World Magnetic Model)	Gauss	WMM local magnitude, inclination and declination based on GNSS coordinates
Pressure Altitude	meters (altitude)	altitude estimate from barometric pressure
SAM	meters (altitude)pressure (milli-bars)temperature (°C) density (kg/m <sup>3</sup> )	altitude as derived from the U.S. Standard Atmospheric Model (SAM) using the sensed barometric pressure and air temperature
Antenna Offset Error	meters	filter-calculated error based on the user-supplied GNSS antenna offset

Table 5 - Estimation Filter Outputs

## 5.4 Sensor Reference Frames

### 5.4.1 Geodetic Frame

The World Geodetic System is the standard for cartography and navigation. The latest revision, WGS84, is the reference coordinate system for GPS, and the 3DM-GX5-45 reports position using this coordinate frame. It also calculates the magnitude of the local gravity vector using the WGS84 reference formulas.

The WGS coordinates are latitude ( $\varphi$ ), longitude ( $\lambda$ ), and height ( $h$ ) above the reference ellipsoid. Latitude ranges from -90 degrees at the South Pole to 90 degrees at the North Pole. Longitude ranges from -180 to 180 degrees, with 0 degrees being the prime meridian. The -180/180 degree switchover occurs in the middle of the Pacific Ocean and includes a section of the International Date Line. The model takes into account the oblateness of the Earth's surface.

A point (P) on or above the Earth in the WGS84 coordinate system is notated as: latitude ( $\varphi$ ), longitude ( $\lambda$ ), and height above the reference ellipsoid ( $h$ ).

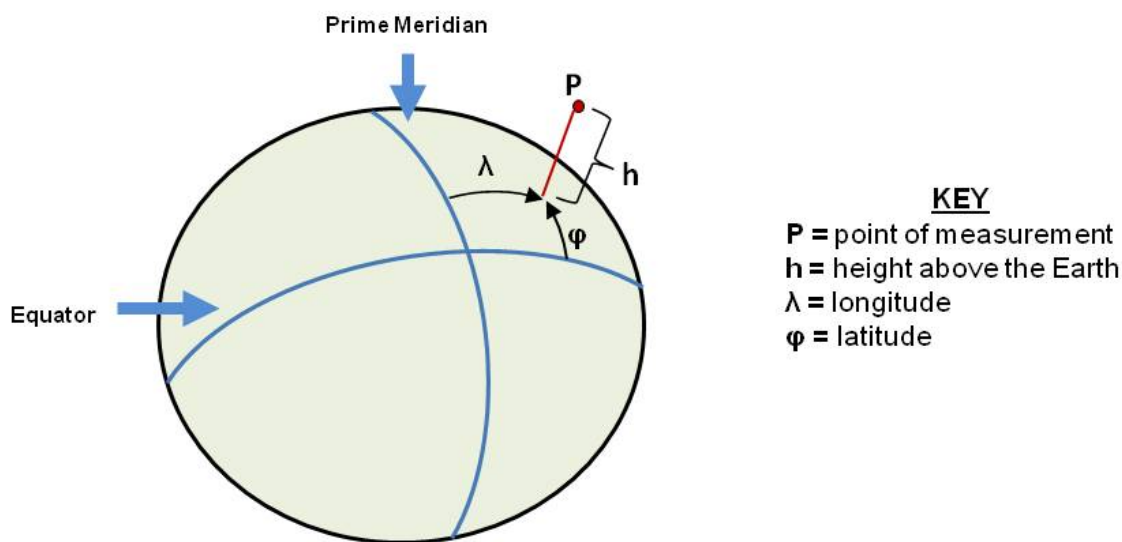

Figure 18 - World Geodetic System (WGS84) Reference Ellipsoid

### 5.4.2 North East Down (NED) Frame

The North-East-Down (NED) frame is a local coordinate frame, which is formed by a tangent plane located at a particular point (current coordinates) on the WGS84 reference ellipse. The NED frame is constructed with the (true) North vector along the line of longitude, the East vector along the line

of latitude, and the Down vector normal to and towards the tangent plane (*Figure 19 - North East Down Frame*). The assumption when using the NED frame is that the local surface can be reasonably approximated by a flat plane. For most applications, this assumption is valid and provides a more intuitive reference frame for expressing velocity and attitude information than a global frame.

The 3DM-GX5-45 reports velocity in this frame and attitude with respect to this frame.

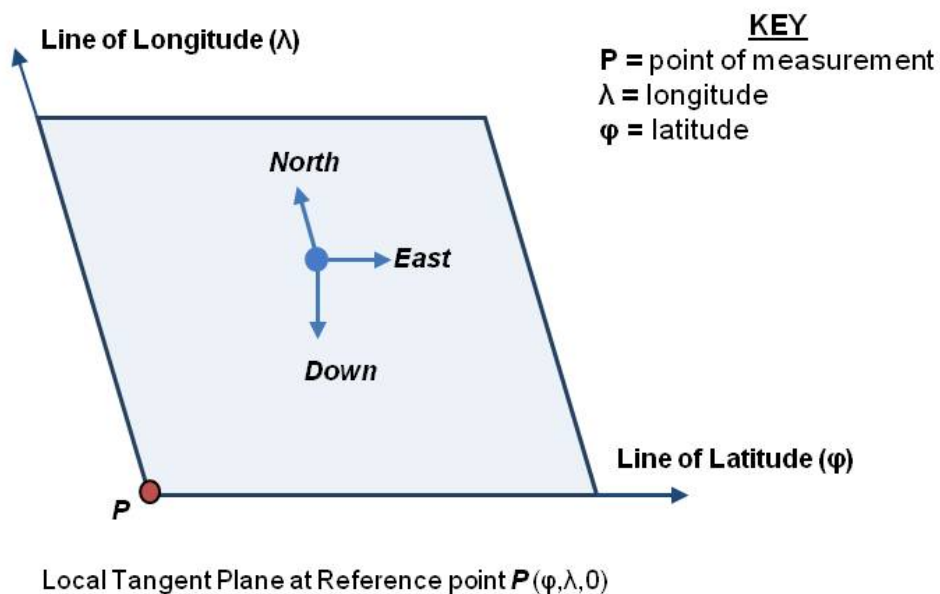

Figure 19 - North East Down Frame

### 5.4.3 Sensor Frame

The sensor frame is indicated on the top of the device and is oriented such that the x-axis vector is parallel with the long side of the sensor and points toward the sensor connector, the y-axis is 90° to the right of the x-axis, and the z-axis goes through the bottom of the sensor (outward). These axes were selected so that when the connector on the device is pointed north and the device is upright and level, the sensor frame will match the NED frame exactly, giving zero rotation.

The 3DM-GX5-45 reports acceleration, angular rate, delta-Theta, delta-velocity, inertial sensor biases and corrections in this frame when no sensor-to-platform frame transformation has been provided ([see Platform Frame on page 32](#)).

The orientation of the sensor frame with respect to the local NED frame can be viewed in the MIP Monitor software at: View > 3D Attitude menu. This window displays the orientation of the sensor in relationship to north and shows measurement origination for acceleration and angular rate. The view can be rotated for clicking, holding, and dragging the image. Options for true north and magnetic north georeferences are available through the magnetic declination correction setting at: Device Settings > EF settings > Geographic.

Refer to the 3DM-GX5-45 dimensional diagram for the location of the measurement origin ([see Reference Diagrams on page 82](#)).

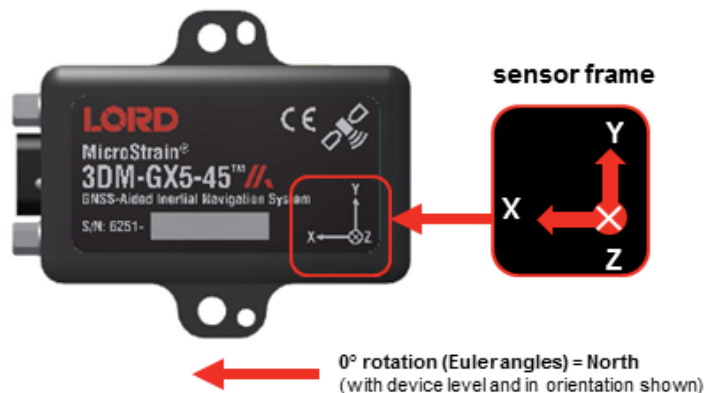

Figure 20 - Sensor Frame

### 5.4.4 Platform Frame

The 3DM-GX5-45 includes the option to define an orientation transformation and offset distance from the sensor frame to a user-definable platform frame. This is useful when the sensor cannot be mounted in the same location or orientation as the desired reference point on the platform frame.



The transformation from sensor to platform frame is defined with Euler angles and is expressed as a rotation from the sensor frame to the platform frame. The offset is the location of the origin of the platform reference frame with respect to the origin of the sensor frame, expressed in the sensor frame.

In the following example (*Figure 21 - Platform Frame Transformation*) the user has defined the desired reference point on the platform frame to be located at the front bumper of the vehicle. In accordance with aircraft co-ordinate systems the platform frame is oriented with the x-axis pointed in the forward direction of travel, the z-axis pointed down, and the y-axis pointed towards the passenger side. The sensor has been mounted face down toward the rear of the vehicle, two meters from vehicle reference location with no offset in the y-axis and z-axis directions. The proper transformation in this example would be: 180 degrees roll, 0 degrees pitch, and 0 degrees yaw, with an offset of [+2, 0, 0] meters (listed as x,y,z).

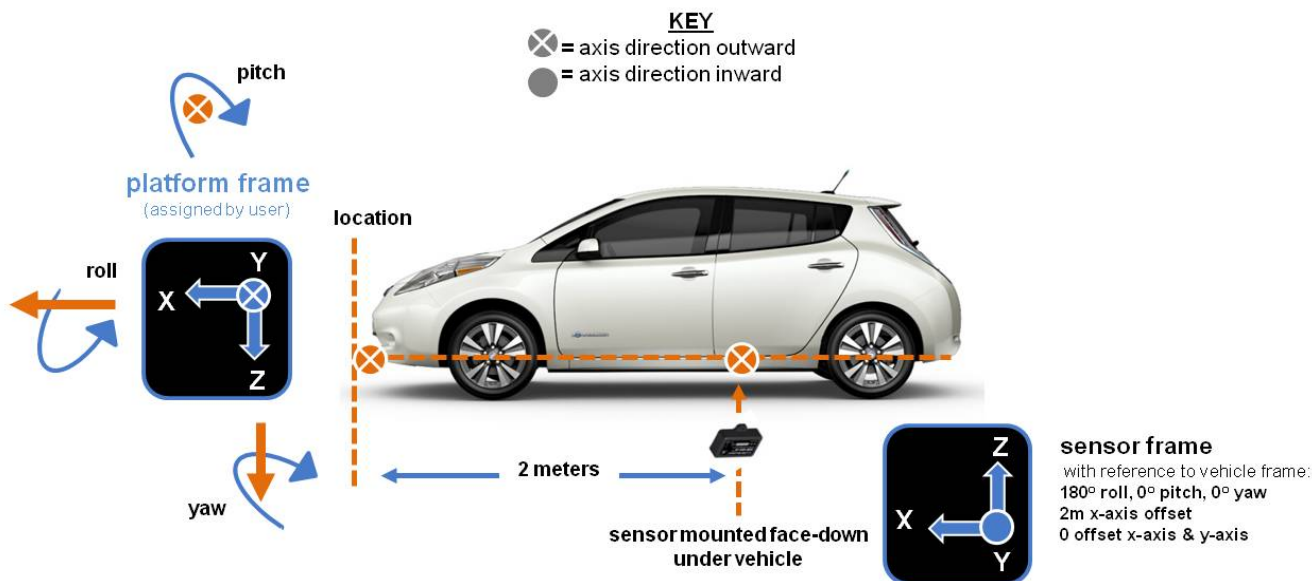

Figure 21 - Platform Frame Transformation

In the MIP Monitor software the transformation and offset settings are entered at: Settings > Device > Estimation Filter > Mounting in the Mounting Offset and Mounting Transformation fields (*Figure 22 - Platform Frame Settings*). To tare pitch-roll, *See Tare Orientation on page 36*).

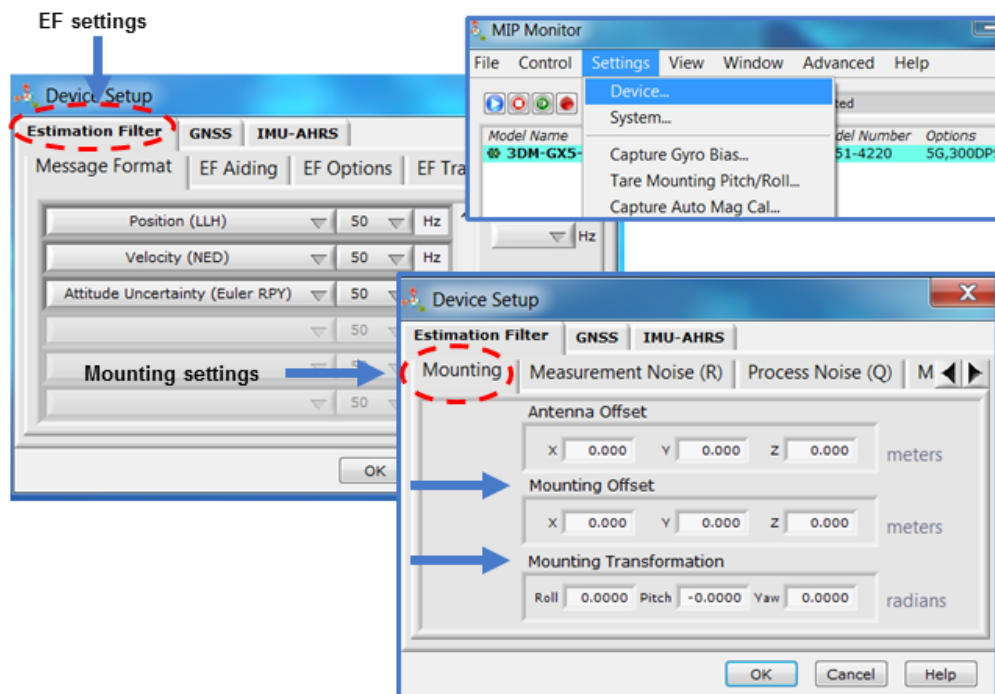

Figure 22 - Platform Frame Settings

The orientation transformation affects the following EF outputs ([see Computed Outputs \(Estimation Filter\) on page 27](#)): attitude, position, linear and compensated acceleration, compensated angular rate, and gravity vector. It also affects the following IMU outputs: acceleration, angular rate, magnetic field vector, delta Theta, and delta velocity.

The offset affects the following EF output: position (LLH).

Transformed acceleration is expressed at the location of the sensor but within the platform frame. For example, if the sensor is offset from the center of gravity (CG), and the platform is undergoing a rotation, an acceleration (in addition to any linear acceleration of the CG) will be sensed in accordance with the following formula: (tangent acceleration) = (angular rate)\*(distance from CG).

## 6. Performance Optimization

### 6.1 Gyroscope Bias

Gyroscope biases (offsets) can be zeroed out to set a baseline value for the static home position and conditions in the application. This should be done after sensor installation.

To set the gyroscope baseline, place the sensor or sensor platform in the desired home position. Allow 2-3 minutes for the sensor to warm up and for the temperature to stabilize for the best bias capture. Select Settings > Capture Gyro Bias ([Figure 23 - Gyro Bias Capture](#)). The sensor must remain stationary for about twenty seconds while the outputs are being measured. A status message will appear when the capture has been completed.

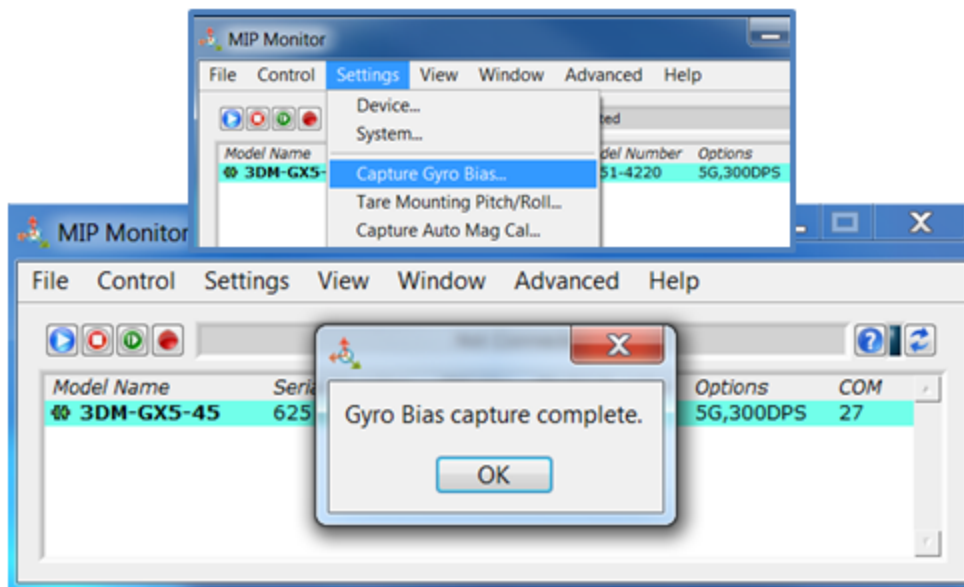

Figure 23 - Gyro Bias Capture

## 6. Tare Orientation

### 6.2 Tare Mounting Pitch-Roll

This function captures the current pitch-roll orientation of the device and sets it as the level reference, providing a convenient way to set the sensor to vehicle frame transformation. For more information, see *Tare Orientation* in the -GX5-45 [Data Communications Protocol Manual](#).

#### NOTE

The filter must be initialized and have a valid attitude output. If the attitude is not valid, an error will be returned. The Tare Mounting Pitch-Roll assumes that the X-axis is co-aligned with the X-axis of the vehicle.

To tare the pitch-roll, select the sensor name in the MIP Monitor software main window, then select Settings > Tare Mounting Pitch/Roll > OK.

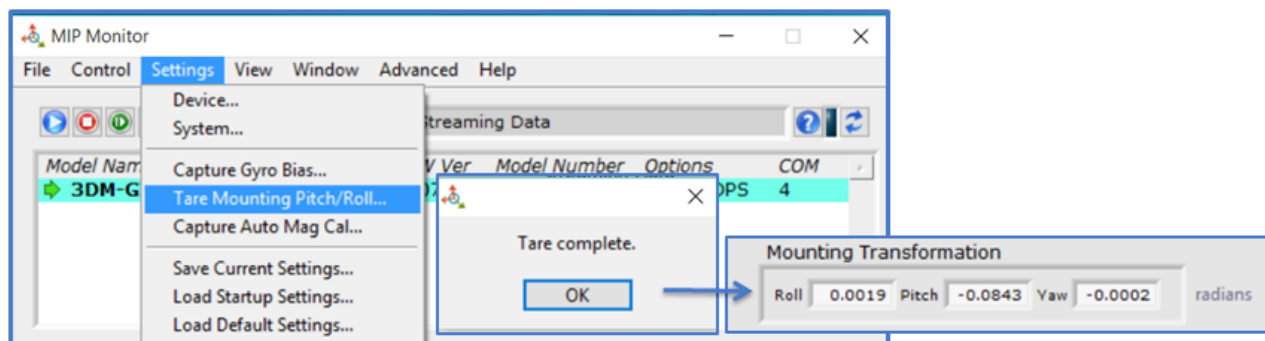

Figure 24 - Tare Mounting Menu

## 6.3 Magnetometer Auto Calibration

### 6.3.1 Enable

Enabling the EF Mag Hard Iron Auto Calibration allows estimation of the magnetometer bias (bias tracking) for purposes of auto-calibration. Enabling the EF Mag Soft Auto Calibration allows estimation of the magnetometer scale factor (scale factor tracking) for purposes of auto-calibration.

To enable, select the sensor name in the MIP Monitor software main window, then select Settings > Device > Estimation Filter > EF Tracking and check the white box to the left of Enable EF Mag Hard Iron Auto Calibration and Enable EF Mag Soft Iron Auto Calibration. Auto Calibration only takes place if the magnetometer is used as a heading aiding source.

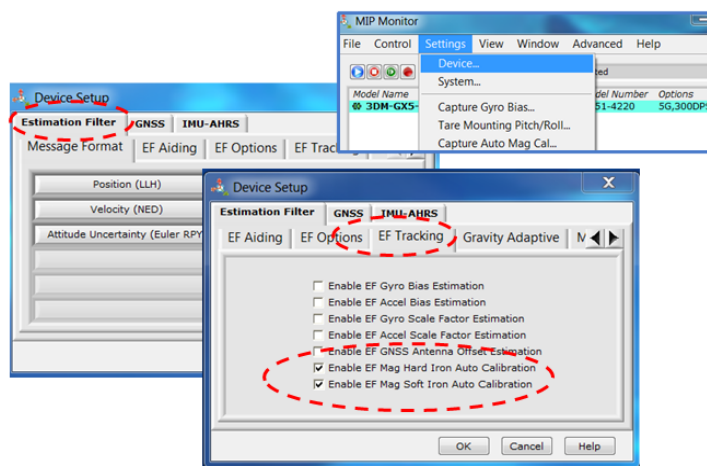

Figure 25 - Enable Auto Mag Calibration

### 6.3.2 Capture

This command captures the current value of the auto-calibration, applies it to the current fixed hard and soft iron calibration coefficients, and replaces the current fixed hard and soft iron calibration coefficients with the new values. This may be used in place of (or in addition to) a manual hard and soft iron calibration ([see \*Manual Magnetometer Calibration on page 39\*](#)) utility such as the LORD MIP Hard and Soft Iron Calibration software, which is included in the MIP Monitor software suite ([see \*Software Installation on page 12\*](#)).

This command also resets the auto-calibration coefficients. The Capture command should only be executed after the vehicle has undergone a series of maneuvers typical of actual operating conditions. These maneuvers are necessary to establish the magnetometer offset and scale factors. For more information, see *Magnetometer Capture Auto Calibration* in the -GX5-45 [Data Communications Protocol Manual](#).

To capture, select the sensor name in the MIP Monitor software main window, then select Settings > Capture Auto Mag Cal > OK > OK.

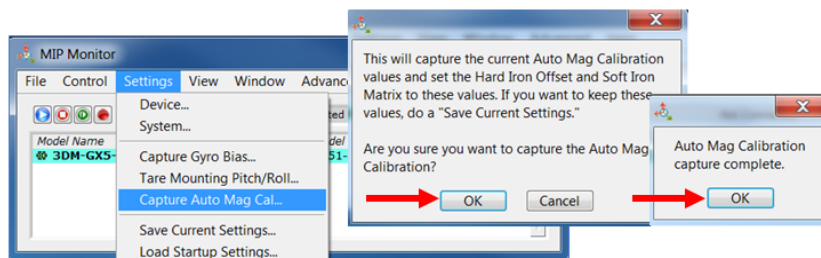

Figure 26 - Capture Auto Mag Calibration

## 6.4 Manual Magnetometer Calibration

Although the 3DM-GX5-45 magnetometers are calibrated at the factory to remove any internal magnetic influences in the device, measurements are still subject to influence from external magnetic anomalies when the sensor is installed. These anomalies are divided into two classes: hard iron offsets and soft iron distortions. Hard iron offsets are created by objects that produce a magnetic field. Soft iron distortions are considered deflections or alterations in the existing magnetic field. Ideally, these influences are mitigated by installing the sensor away from magnetic sources, such as coils, magnets, and ferrous metal structures and mounting hardware. However, often these sources are hard to avoid or are hidden.

To mitigate this effect when using the 3DM-GX5-45 magnetometer to aid in heading estimations, a field calibration of the magnetometer after final installation is highly recommended. This can be accomplished using LORD Sensing MIP Hard and Soft Iron Calibration software. This software is included with the MIP Monitor Software Suite ([see Software Installation on page 12](#)). The following are instructions for field calibrating the magnetometers:

1. Connect and power-on the sensor as normal, and open the MIP Hard and Soft Iron Calibration software.
2. Enter the Local Magnetic Field information ([Figure 27 - Sensor Menu](#)) for the sensor to account for magnetic influences inherent to the sensor's geographic location on the Earth. As needed, use the WMM on Web button to access a World Magnetic Model calculator on the British Geographic Survey website. This site, and similar sites, generate Local Magnitude F and Local Inclination I values based on latitude and longitude entries. In the calculator solution, these values will be found in row MF, column F and row MF, column I, respectively.

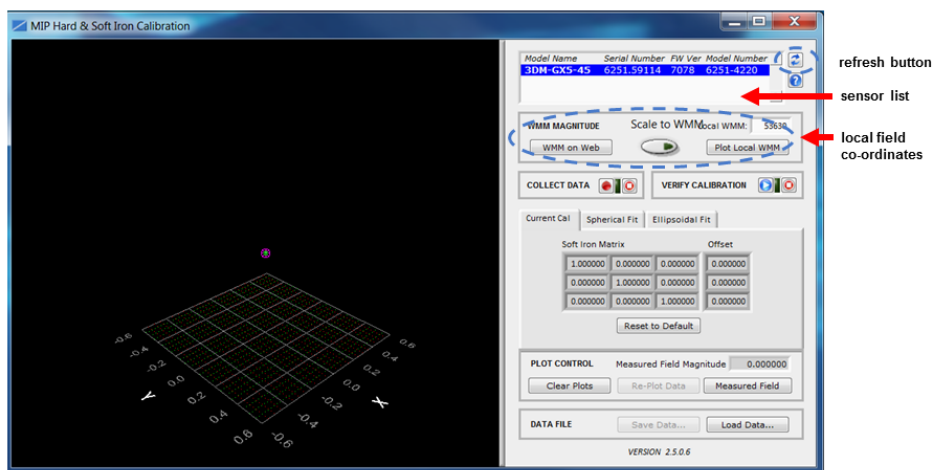

Figure 27 - Sensor Menu

- The sensor should automatically appear in the sensor list (*Figure 27 - Sensor Menu*). If not, use the Refresh button to query it and then select the sensor.
- Select the Arm Recording button next to Collect Data (*Figure 28 - Collect Calibration Data*). The software will begin taking readings, as indicated by the points counter in the graphing window. The maximum number of points is 1000, however 100 is usually adequate. As the readings are taken, rotate the sensor or sensor platform in all possible directions to get a complete profile of the baseline magnetic influences throughout the sensor frame. Data points will appear on the graph in red. For mobile sensor platforms, such as ground vehicles, move the platform as much as possible to simulate actual use without exposing it to excessive magnetic sources (such as driving over railroad tracks or near steel pilings). The intention is to get a baseline of the platform in a neutral environment that still accounts for the platform itself in all orientations. For stationary platforms the baseline may include significant magnetic influences that will be present during operation.

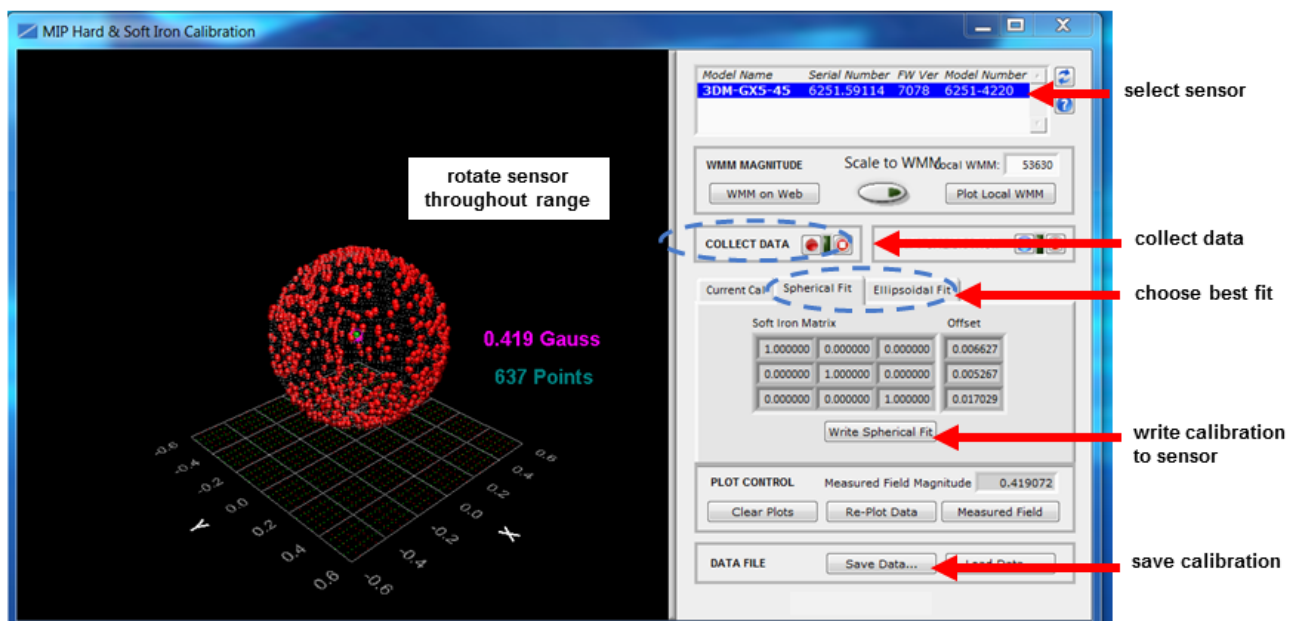

Figure 28 - Collect Calibration Data

- When all possible rotations are completed, select "Stop Streaming" next to Collect Data, and then select Save Data to save the calibration data points on the host computer (*Figure 28 - Collect Calibration Data*).
- Click the Spherical Fit or Ellipsoid Fit button, depending on the application. Spherical Fit is often best for applications with calibration rotations restricted to a 2D plane: for example, a ground vehicle or a boat, because it will not likely not be rotated on all three axis. Ellipsoid Fit



is generally a better correction when soft iron effects are present but only if enough data points can be collected in all quadrants. If the range of motion is restricted in one dimension, the Spherical Fit may be the best choice. If there are enough points in all dimensions, the Ellipsoid Fit may be better. Generally, if the Spherical and Ellipsoid Fits are close in the mean diameter, then the Ellipsoid Fit will be the best choice.

7. Click Write Spherical Fit or Write Ellipsoid Fit accordingly. This will write the values to the sensor memory.
8. Cycle power to the sensor if prompted, and then use the Refresh button, if needed, to re-establish communication with the sensor.
9. Start a calibration verification by clicking the Start Streaming Data button next to Verify Calibration ([Figure 29 - Verify Calibration](#)). Rotate the device in all orientations in the same way as during calibration. When completed click the Stop Streaming Data button next to Verify Calibration. The resulting data points should be on or near the spherical grid. Hold the left mouse button and drag to rotate the image. The mouse wheel can be used to zoom in and out. If the fit is not close, the sensor may require re-calibration. If it is close, as shown, calibration and verification is complete.

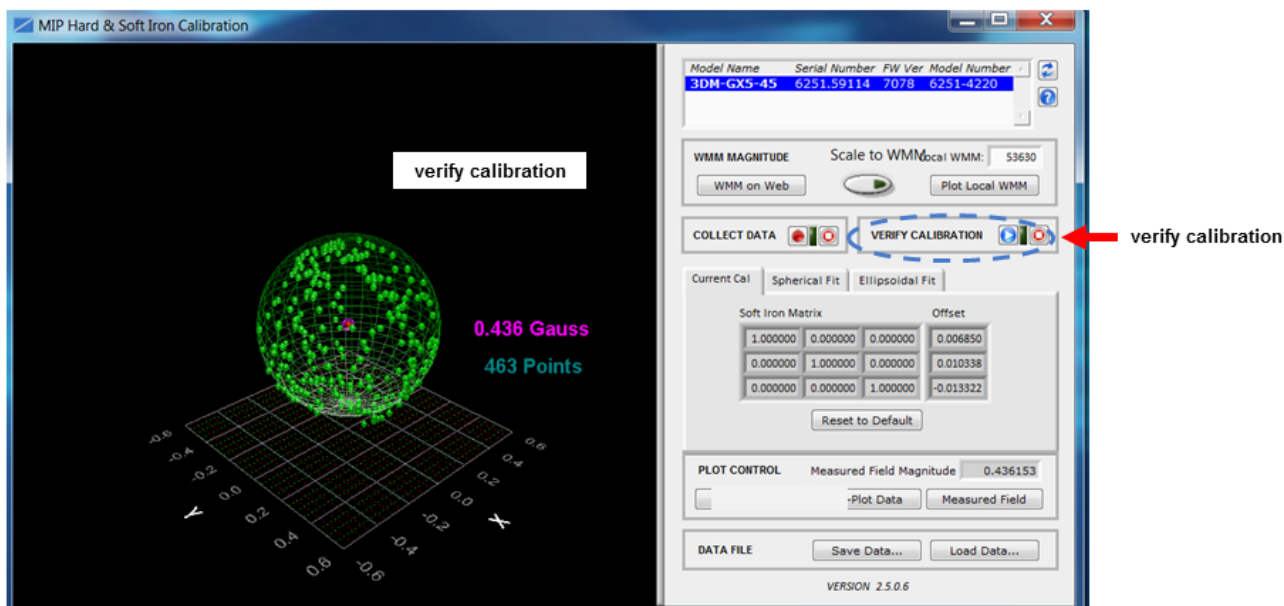

Figure 29 - Verify Calibration

## 6.5 Estimation Filter Aiding

There are four primary categories with sub-menus in each to customize GNSS, heading, pitch-roll, and altitude. To enter the Estimation Filter Aiding menu, select the sensor name in the MIP Monitor software main window, then select Settings > Device > Estimation Filter > EF Aiding.

1. GNSS Source has three options including, None, Internal GNSS, and External GNSS Message ( [see GNSS External Receiver on page 62](#)).
2. Heading Aiding has eight options including, 1) None, 2) Magnetometer, 3) GNSS velocity, 4) External Heading Message, 5) Mag & GNSS, 6) GNSS Velocity & External Msg, 7) Mag & External Msg, 8) Mag & GNSS Vel & Ext Msg. For more information, ( [see Heading Aiding Settings on page 43](#)).
3. Pitch/Roll Aiding has two options including, None and Gravity Vector.
4. Altitude Heading has two options including, None and Pressure Altimeter.

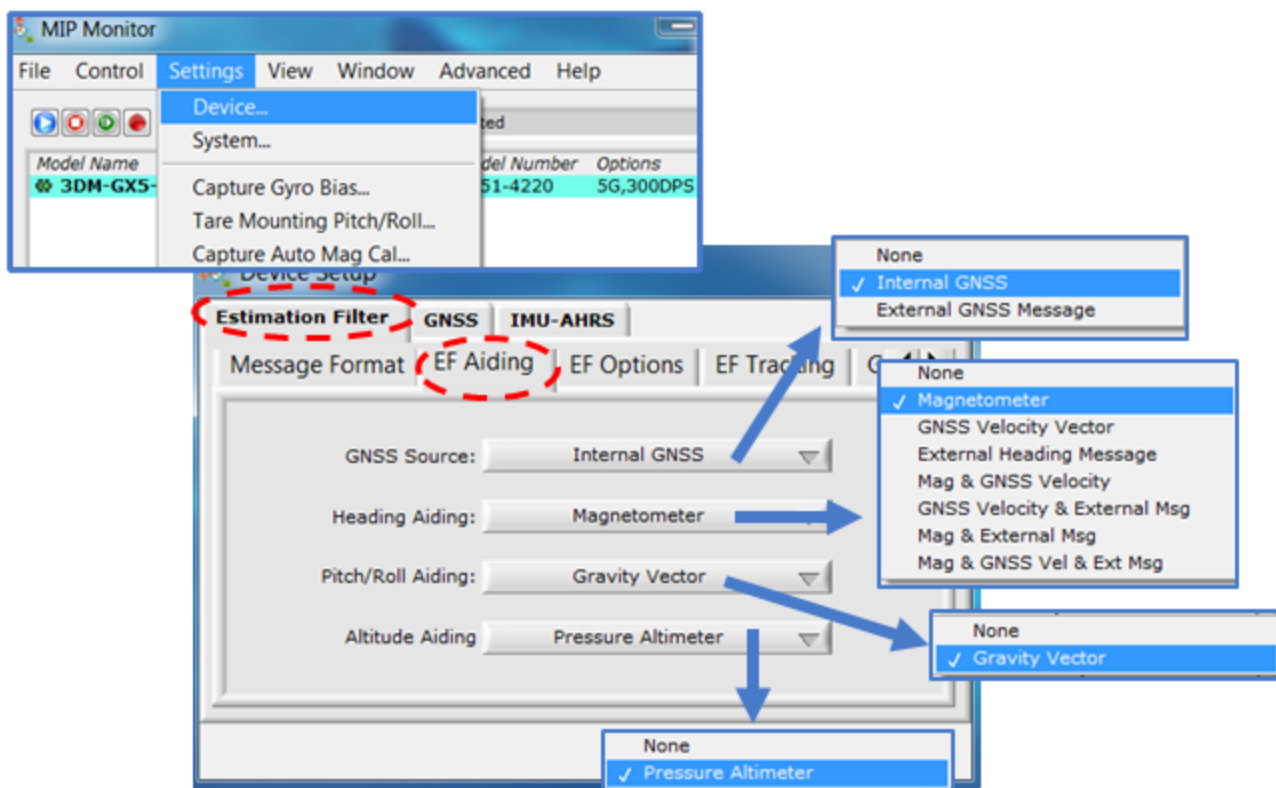

Figure 30 - EF Aiding Options Menu

## 6.6 Heading Aiding Settings

Device settings are stored in the sensor memory. Only the configuration options that are available for the type of sensor being used are displayed in the configurations menus. The -GX5-45 has eight heading options.

If the setting is an external reference, the user has to provide a heading reference (for example, [see GNSS External Receiver on page 62](#)). If the setting is none, the estimated heading will drift when little-or-no changes in velocity are sensed (e.g. when stationary or traveling in the same direction at a constant velocity). If the setting is the magnetometer, there will be no drift, but the accuracy will only be as good as the magnetometer measurement. If using velocity as a heading reference, the sensor (or sensor platform) has to be moving, or there will be no heading reading. When using the combination settings, multiple heading aiding sources may be used. For example, if an external heading source is available but a magnetometer backup heading is desired, select the Mag & External Message option.

For all settings, moving the platform in a dynamic way will assist in capturing an accurate heading.

To enter the Heading Aiding menu, select the sensor name in the MIP Monitor software main window, then select Settings > Device > Heading Aiding:

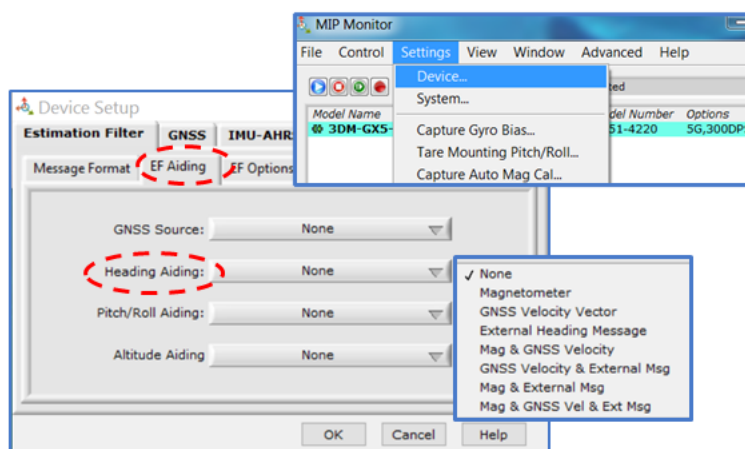

Figure 31 - Heading Aiding Settings

## 6.7 Vehicle Dynamics Mode

The vehicle dynamics mode setting adjusts the Kalman filter expectation of the vehicle's motion. By doing this, the filter is better able to account for the effects that different dynamic platforms have on changes in GNSS satellite pseudo-ranges. Each platform setting (portable, automotive, airborne, and airborne-high g-force) have different velocity and altitude limitations.

In the MIP Monitor software this setting is found at: Settings > Device > Estimation Filter > EF Options > Vehicle Dynamics Mode ([Figure 32 - Vehicle Dynamics Setting](#)).

Refer to the 3DM-GX5-45 Data Communications Protocol (DCP) for more information about this setting.

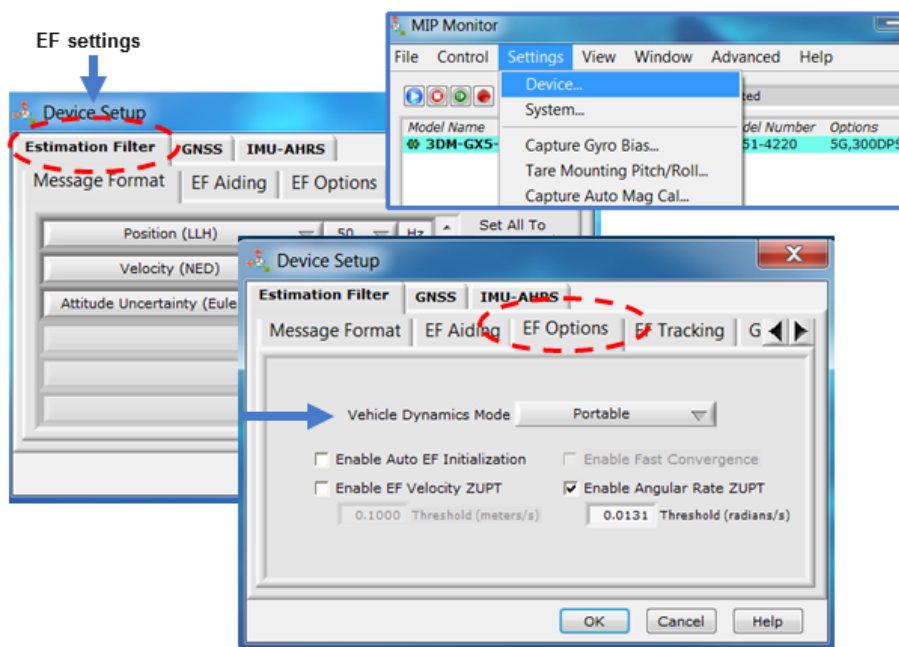

Figure 32 - Vehicle Dynamics Setting

## 6.8 Adaptive Anomaly Rejection

### 6.8.1 Gravity Adaptive

Enabling this feature allows the filter to stabilize attitude readings when undergoing linear accelerations. The bandwidth setting determines the cutoff frequency of the filter applied to linear acceleration changes ([see Communications Bandwidth on page 47](#)). The high and low limits determine the trigger points at which the stabilization is applied. The limit values are in meters/second<sup>2</sup> and the bandwidth is in Hz. Find this setting by selecting the sensor name in the MIP Monitor software main window, then select Settings > Device > Estimation Filter > Gravity Adaptive.

Manual Adaptive (default setting): Enter user-set fixed values.

Auto-Adaptive: Automatically estimates the values internally.

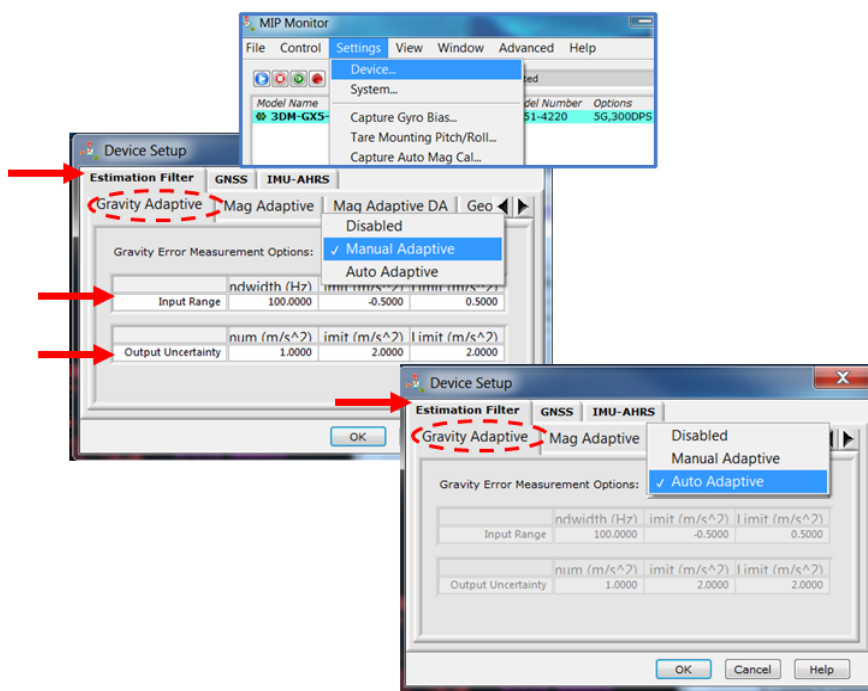

Figure 33 - Gravity Adaptive Settings

## 6.8.2 Mag Adaptive

Enabling this feature will allow the filter to reject magnetometer readings when the magnitude error exceeds the high limit (in  $m/s^2$ ). The bandwidth (in Hz) sets the cutoff frequency of the low pass filter applied to the magnetometer error (*see Communications Bandwidth on page 47*). Find this setting by selecting

Manual Adaptive (default setting): Enter user-set fixed values.

Auto-Adaptive: Automatically estimates the values internally. It is important to have accurate location information (lat long) in order to have an accurate value for the local magnetic field magnitude.

### NOTE

For best results, perform a hard and soft iron calibration or enable Auto-Mag calibration prior to initiating the Mag Adaptive function.

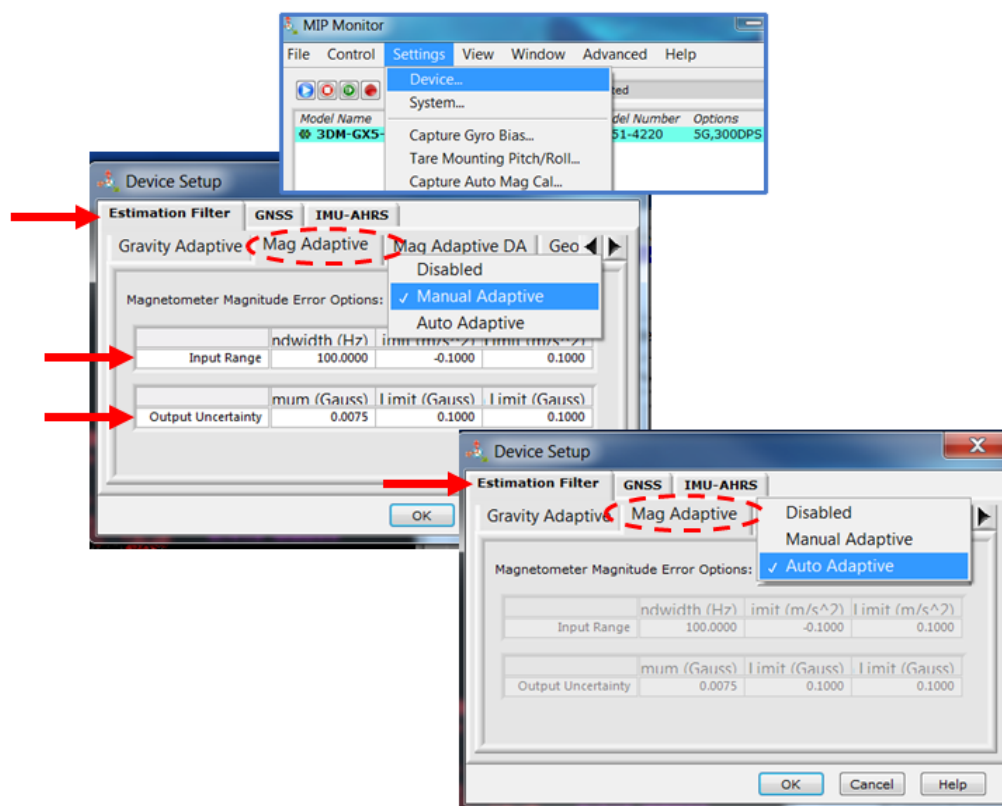

Figure 34 - Mag Adaptive Settings

## 6.9 Angular Rate and Acceleration Limits

The 3DM-GX5-45 angular rate and acceleration range depend on the sensors installed in the device. Exceeding the specified range for either sensor will result in estimated state errors and elevated uncertainties until the over-range event is corrected and the filter can resolve the errors.

## 6.10 Communications Bandwidth

When selecting sensor and estimation outputs to be recorded, communication bandwidth considerations should be taken into account, especially when using RS232 serial communications. Lower baud rates equate to lower communication bandwidth, which can be consumed quickly by selecting a large number of measurements at high sample rates. Overrunning the communication bandwidth will result in dropped data packets. Most computer RS232 ports are limited to 115,200 baud even though the 3DM-GX5-45 is capable of running at 921,600 baud.

## 6.11 Platform Frame Transformation

The transformation from the sensor frame to the platform frame ([see Platform Frame on page 32](#)) should be defined to the highest angular accuracy possible. The easiest way to accomplish this is to co-align the frames. If this is not possible, using a simple transformation (such as 90 or 180 degree rotations on a single axis) is preferred. For complex transformations between the frames, a calibration should be performed or analysis from a model should be conducted.

## 6.12 GNSS Parameters

The receiver used in the 3DM-GX5-45 has a speed limitation of 500 meters/second in accordance with the United States International Treaty in Arms Regulation (ITAR) restrictions.

To use the 3DM-GX5-45 GNSS receiver, the external antenna must be connected and positioned with unobstructed line of sight to the sky in order to achieve satellite lock. Operating environment can also effect GNSS operation, and the device must be operated within specifications. When using the magnetometer for heading aiding, non-magnetic antenna connections like the antenna adapter cable included with the 3DM-GX5-45, must be used.

GNSS outages should be kept to a minimum. As an outage period progresses, the errors in the integration of the inertial sensors compound, causing the solution to diverge. Position errors grow exponentially, and velocity grows linearly with measured acceleration error, and attitude errors will grow linearly with estimated bias error. Monitoring uncertainty metrics during GNSS outage conditions will provide an indication of the estimation accuracy.

### 6.13 GNSS Antenna Offset

GNSS antenna offset is the distance of the antenna from the GNSS receiver in the 3DM-GX5-45. Errors in this offset affects the accuracy of the EKF position, velocity, and attitude solutions. The MIP Monitor allows entry of the offset in the Settings > Device > Estimation Filter > Mounting > Antenna Offset (*Figure 35 - Antenna Offset*).

For the best possible filter solution, the GNSS antenna offset should be defined to the highest degree possible, preferably down to at centimeter. Inaccuracies become non-negligible at 2 to 3 centimeters. The user should strive to minimize this distance, as large offsets (tens of meters or more) will result in position oscillation due to small orientation inaccuracies. For example, a 1 degree error in attitude with a 10 meter antenna offset would result in a position error of approximately 0.17 meters. If the offset was only 1 meter, the position error would be 1.7 cm.

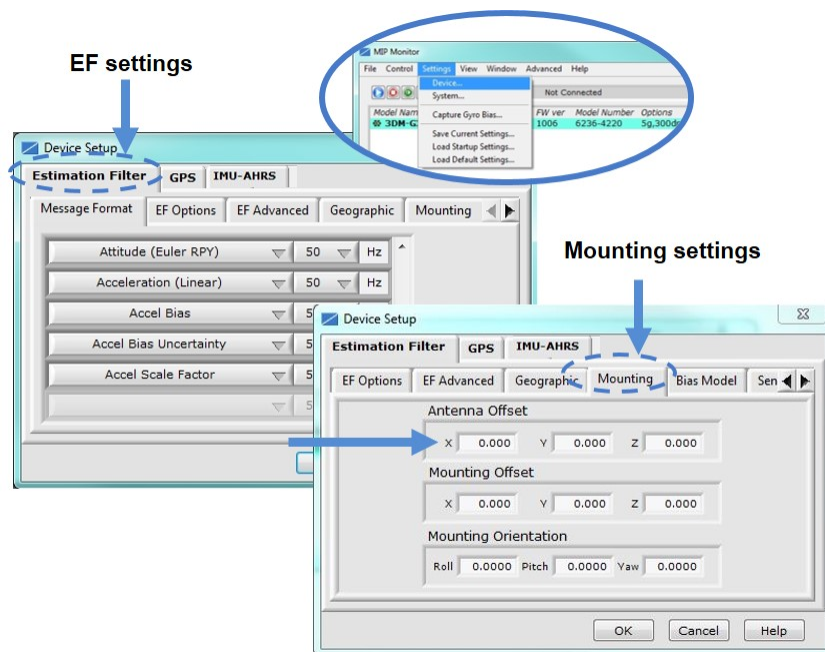

Figure 35 - Antenna Offset



## 6.14 Estimation Filter Operation

The 3DM-GX5-45 combines the information from a GNSS receiver and the IMU sensors to calculate a navigation solution that incorporates the strengths of the individual systems while minimizing their weaknesses.

The GNSS solution is bounded and typically very good, but it is susceptible to several error sources. Due to the geometry of the satellite constellation, vertical position accuracy is typically less than horizontal position accuracy. Additionally, errors from atmospheric and multipath effects, as well as clock error, further degrade the accuracy of the solution. Arguably the largest problem with a GNSS-only solution for navigation is that a single receiver cannot give users the orientation of the platform unless the sensor coordinate frame is co-aligned with the platform velocity vector. For a lot of applications, this assumption is too restrictive. For example, the pitch of an aircraft typically does not match the angle the velocity vector makes with the horizon. This occurs because the aircraft's wings must be at an angle with the oncoming air to generate lift. Making the assumption that the two values are the same and using the pitch angle as an input to an autopilot is a mistake. In order to obtain the attitude of the vehicle, something more is needed.

In a conventional Attitude and Heading Reference System (AHRS) several sources of error exist when making attitude estimates. First, the algorithm assumes the acceleration vector is dominated by Earth's gravity, with only transient linear accelerations. When long-duration linear accelerations are experienced, such as when an aircraft performs a sustained 2G turn, the AHRS will report incorrect pitch and roll angles. This error is the direct result of the assumption that the accelerometers are only sensing Earth's gravity. A second source of error occurs when the device attempts to measure the Earth's magnetic field. This field is very weak compared to the numerous magnetic anomalies typically found on platforms, or naturally occurring close to the Earth's surface. If the magnetic anomalies in the platform remain constant with respect to the sensor (no translation or rotation between the two) they can be compensated for by performing a hard iron and/or soft iron calibration of the magnetometers internal to the 3DM-GX5-45 ([see Manual Magnetometer Calibration on page 39](#)). The hard iron calibration compensates for magnetic effects that cause offsets in the magnetic field (additive effects). The soft iron calibration compensates for effects that cause a non-uniformity of the magnetic field which results in an ellipsoidal distortion in the field. Non-constant and external sources, such as those found when traveling through cities, cannot be compensated and may cause large errors in the heading estimation. Transient errors can be suppressed when the magnetometer readings are combined with information from the gyroscopes but only for periods on the order of a few seconds. Longer duration anomalies will result in heading errors. A third source of error occurs when attempting to navigate between geographic way-points expressed in latitude and longitude. This error is due to the difference between detecting magnetic north, which is output by the AHRS sensor, and true north, which is used to define lines of longitude. If the AHRS is always used in one geographical location, the user can correct for this difference using a constant offset. If the AHRS is used over a wide range of longitude, the magnetic declination must be calculated from a magnetic model or obtained from GNSS subsystem

which outputs this data. The greatest problem with an AHRS is that it is an attitude-only device and requires a GNSS for position and velocity.

As a first attempt at an improved navigation solution, a user could get position and velocity from a GNSS receiver and attitude from an AHRS. This is an acceptable solution for many navigation problems, but is susceptible to the errors described above. A more accurate estimation of position, velocity, and attitude can be found by fusing the data from these two independent systems using a Kalman filter.

The 3DM-GX5-45 runs a loosely-coupled Extended Kalman Filter. In a loosely-coupled filter, the inertial sensors in the IMU are used to propagate the state estimation at a high rate (500 Hz); whereas the GNSS position and velocity measurements are used to periodically correct the state (4 Hz.) This form of Kalman filter is called a sensor fusion filter as it combines similar information from multiple sources in a complementary way. This combination takes into account the statistical properties of the sensors used, providing a better estimate of the true state than either system individually. The 3DM-GX5-45 has a full-state dynamics model. The state propagation utilizes Newton's and Euler's equations of motion with the acceleration and angular rate treated as control inputs. In addition to the GNSS measurement, the IMU magnetometer is available to correct heading mis-alignments which occur during periods of low dynamics. The magnetometer corrections can be disabled for applications where large, non-constant magnetic interference sources exist, which would impair their use (such as when mounting the 3DM-GX5-45 on a gimbal close to the frame of a ground vehicle).

The Kalman filter estimates the full states of position, velocity, attitude, and sensor parameters for a total of 34 states: 3 position, 3 velocity, 4 attitude (quaternion), 3 accel bias, 3 gyro bias, 3 accel scale factor, 3 gyro scale factor, 9 magnetometer, and 3 GNSS antenna offset error states. The bias states are estimated in order to compensate for the time-varying biases inherent in MEMS inertial sensors, which are the largest error sources for these devices. The bias states are subtracted from the gyroscope and accelerometer inputs, thus providing more accurate inertial data to the propagation stage of the filter. This enhances overall accuracy and is especially useful during GNSS outage conditions.

The Kalman filter also provides statistical information about the quality of the estimated states described in a covariance matrix. The diagonal terms of the matrix are the variance of each state, thus the square root of these values are 1-sigma standard deviations. These values give the filter's estimation of how well it knows the individual states, given what it knows about the statistical properties of the noise sources of the various sensors and also provide feedback to the user as uncertainty values. The GNSS position and velocity noise are not white but are treated as such in a loosely-coupled filter. This approximation results are not optimal, but the advantages of this type of filter outweigh that disadvantage.

## 6.15 Estimation Filter Convergence

### 6.15.1 Initial Convergence

After a successful initialization, a period of convergence for the Kalman filter states occurs. Position, velocity, roll angle, and pitch angle typically converge very quickly. Heading, accelerometer bias, and gyro bias take more time to converge. If the initial attitude estimate provided to the filter is well outside of the true attitude, the filter may diverge and never recover. This is most likely to occur for the heading estimate when a poor value is used for initialization and when the vibration environment is strong. Should this occur, it is recommended that the filter be reset and new attitude estimate provided. Refer to the 3DM-GX5-45 for the various ways of providing an initial attitude estimate through a user-designed interface.

### 6.15.2 Bias Convergence

Accurate estimation of the biases can take several minutes to converge, therefore after the filter is initialized, the free-inertial performance will continue to improve until the bias estimations settles. The MEMS sensor manufacturers quote bias drift stability numbers which correspond to the expected drift in bias while the sensor is operating. The filter attempts to track the changing biases over time, and a user can expect these bias estimates will be non-constant during a navigation run.

### 6.15.3 Output Uncertainty

The 3DM-GX5-45 estimation data set includes a filter status field that contains a set of status flags. These flags pertain to high covariance values for position, velocity, attitude, and inertial sensor parameters. These flags should be monitored and cross-checked against the corresponding uncertainty fields when they appear. This can assist in determining how trustworthy the solution generated by the Kalman filter is. When the filter is first initialized, it is likely that some of these values will be beyond limits, and the flags may be asserted. This fact should be taken into account when developing automated monitoring systems.

## 6.16 Vibration Isolation

The 3DM-GX5-45 should be isolated from strong vibrations as much as possible. Strong, continuous vibrations appear as unaccounted noise to the estimation filter, degrading its performance. When vibration cannot be isolated, making adjustments to the Accelerometer Noise and Gyro Noise parameters to account for the additional noise will improve the accuracy of the estimation filter outputs.

## 6.17 IMU Sensor Calibration

All of the internal sensors in the 3DM-GX5-45 are calibrated when the device is manufactured, and the calibration values are saved in the device memory. With the exception of the magnetometer field calibration ([see \*Manual Magnetometer Calibration on page 39\*](#)) recalibration is not required unless the device has been under conditions that exceed the operating specifications. For example, if the sensor has been exposed to excessive shock beyond the rated g-force, performance may be compromised. Indications of internal sensor damage may be seen as excessive measurement offsets or drift when the sensor is in a neutral motionless position.

## 6.18 Temperature Compensation

All sensor conversion and calibration formulas include temperature compensation. All computed outputs and IMU sensor outputs are automatically adjusted for local temperature ([see \*Direct Sensor Measurements \(IMU Outputs\) on page 23\*](#)).

## 6.19 Import and Export Settings

The import and export settings features provide a consolidated file of the user settings, enabling Device Settings information to be saved and shared. For example, exporting settings to the LORD technical support team helps facilitate fast and accurate resolution of technical issues.

To import the sensor settings, select the sensor name in the MIP Monitor software main window, then select Settings > Import Settings, then follow the prompt to choose where the file will be saved and name the file.

To export the sensor settings, select the sensor name in the MIP Monitor software main window, then select Settings > Export Settings, then follow the prompt to choose where the file will be saved, and select OK. The file will be named by default using the sensor name, serial number, date and time.

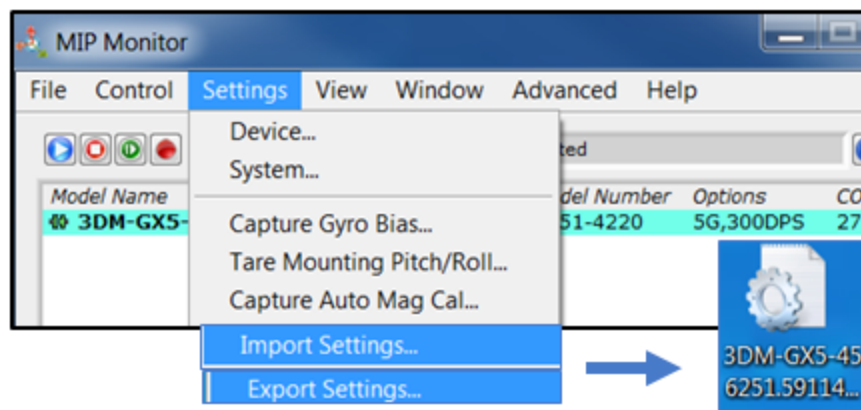

Figure 36 - Import/Export Settings Menu

## 7. Sensor Installation

### 7.1 Sensor Mounting

The 3DM-GX5-45 sensor housing is rated for indoor use only, unless used inside a protective enclosure. When using the internal GNSS receiver, the GNSS antenna connector on the side of the sensor must be accessible. The connector and cable must be non-magnetic. The MMCX to SMA adapter cable supplied with all 3DM-GX5-45 is non-magnetic.

The sensor has two mounting tabs with holes for fastening. Mounting screws should be 4-40 brass or stainless steel. Nylon washers and lock-tite are recommended. There are two additional holes used for precise alignment with 2mm dowel pins. One of the holes is slotted to allow for relaxed pin positioning accuracy. The sensor can be mounted in any orientation, as required for the application (*see [Sensor Reference Frames on page 30](#)*). The axes are labeled on the face of the sensor for reference, and the sensor measurement origin is shown in the sensor dimensional drawing (*see [Reference Diagrams on page 82](#)*).

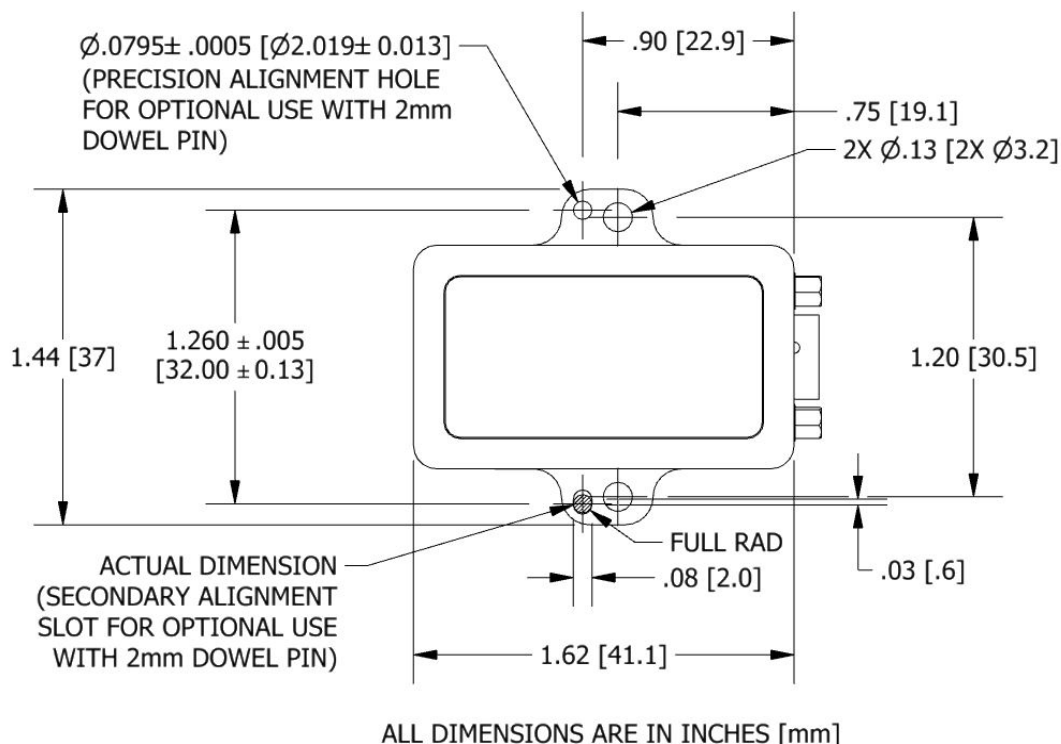

Figure 37 - Mounting the Sensor

## 7.2 GNSS Antenna Installation

The GNSS antenna cable is plugged into the non-magnetic SMA-to-MMCX adapter cable supplied with the 3DM-GX5-45. The adapter cable is then plugged into the 3DM-GX5-45 housing (*see [Interface and Indicators on page 10](#)*). The GNSS antenna provided with the starter kit can be mounted installing two M3 screws into the base of the antenna (*Figure 38 - GNSS Antenna Mounting*). Alternate antenna and cables, as well as external GNSS and receivers, can be used with the 3DM-GX5-45 when appropriate for the application if at least 9 are non-magnetic from the device. *see [Alternate GNSS Equipment on page 61](#)*).

The antenna must be mounted with an unobstructed line of sight to the sky in order to establish GNSS satellite links. This can be accomplished through a window or more optimally by placing the antenna outdoors. Use the GNSS Monitor in the MIP Monitor software to observe satellite link strength during installation to optimize placement (*see [Global Navigation Satellite System \(GNSS\) Outputs on page 25](#)*). For the most accurate GNSS readings and EF outputs the antenna position, with reference to the sensor, should be carefully measured and entered as the Antenna Offset setting (*see [GNSS Antenna Offset on page 48](#)*).

### CAUTION

When using GNSS antennas with magnetic bases, do not bring the antenna in close proximity to the sensor either in handling or permanent installation as it may disrupt the magnetometers within the 3DM-GX5-45.

### NOTE

Only an amplified broadband GNSS antenna such as the one included in the LORD connectivity kit should be used with this device. Using a GPS-only antenna will reduce the ability of the receiver to get valid satellite data from GLONASS and BeiDou.

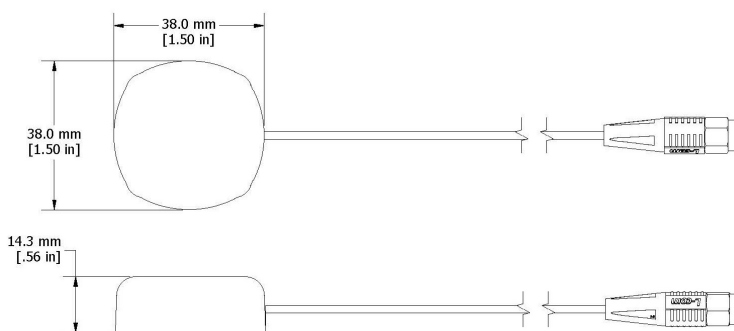

Figure 38 - GNSS Antenna Mounting

## 8. OEM System Integration

The 3DM-GX5-45 starter kit comes with everything that is needed for sensor configuration, operation, and data collection. However, many applications will require custom solutions because of physical or environmental constraints, required sensor output processing, or for integration into control systems that react to the sensor outputs. For these applications the 3DM-GX5-45 is available as a stand-alone component with optional interface connectors. The communication protocol used for configuring and acquiring sensor data and estimations outputs is available for these applications as well.

### 8.1 Data Communications Protocol (DCP)

The LORD Sensing MIP Data Communications Protocol includes all commands available for controlling and acquiring data from the 3DM-GX5-45, including many that are not available in the MIP Monitor software. Programming is performed through a standard serial interface program. The programming interface is comprised of setup and control commands and a very flexible user-configurable data output format. The commands and data are divided into four command sets and three data sets corresponding to the internal architecture of the device. The protocol is packet-based. All commands, replies, and data are sent and received as fields in a message packet. The packets have a descriptor-type field based on their contents, so it is easy to identify if a packet contains commands, replies, or data.

The MIP software developers kit (SDK) includes sample code and can be found on the LORD Sensing website Support page or by contacting Technical Support ([see \*Technical Support on page 70\*](#)).

The LORD Sensing MIP Data Communications Protocol describes each command description, message syntax, and message option. It also provides examples, and can also be found on the LORD Sensing website or through Technical Support.



### 8.1.1 Packet Builder

To expedite program development, a packet builder tool is included in the MIP Monitor software. The packet builder allows users to send multiple packets to the 3DM-GX5-45 and view the resulting reply data.

Applicable protocol structure and design is described in the 3DM-GX5-45 [Data Communications Protocol](#). For additional help, contact Technical Support ([see Technical Support on page 70](#)).

To use the packet builder select Advanced > Packet Builder from the MIP Monitor main window ([Figure 39 - Packet Builder](#)). The sensor must be in the Standard communications mode to use this feature.

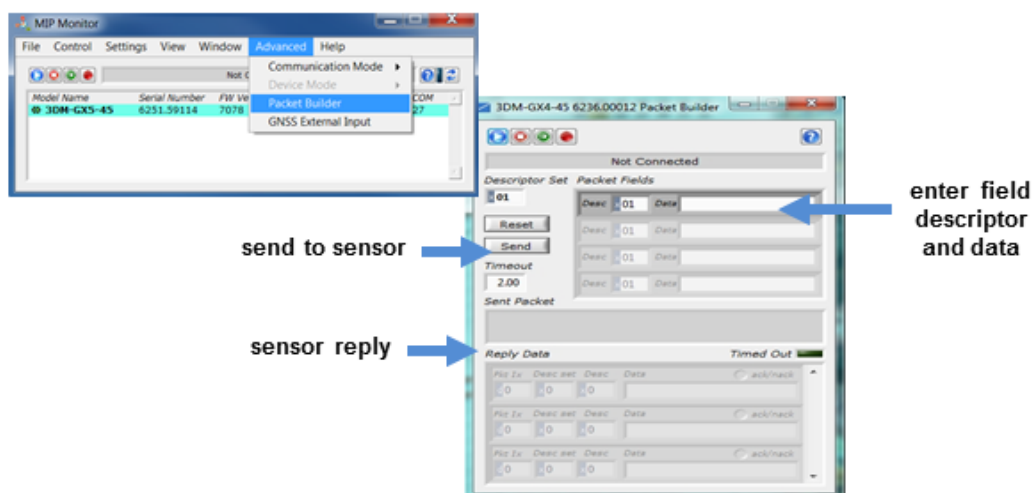

Figure 39 - Packet Builder

### 8.1.2 Sensor Direct Mode

The MIP Monitor software can be used to put the sensor in a mode that allows direct programmatic access to the internal Inertial Measurement Unit (IMU). The IMU has its own processor and protocol commands and native data outputs from the individual IMU sensors that may not be available in MIP Monitor.

When in Sensor Direct mode the device normal functionality is not available. The protocol commands used to interface with the IMU are a subset of the standard LORD Sensing MIP Data Communications Protocol and are further described in the LORD Sensing MIP Data Communications Protocol manual. For additional information contact LORD Sensing Technical Support ([see Technical Support on page 70](#)).

To enter this mode select Advanced > Communications> Sensor Direct from the MIP Monitor main window. Once in this mode the device status message will indicate Sensor Direct Mode ([Figure 40 - Sensor Direct Mode](#)).

To exit Sensor Direct Mode select the Refresh button in the MIP Monitor at any time, or use Advanced > Communication menu to select the Standard operating mode.

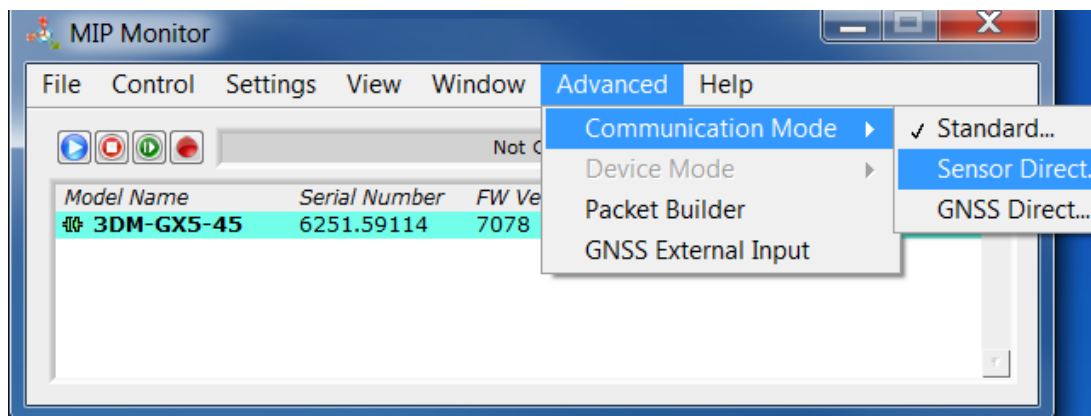

Figure 40 - Sensor Direct Mode

### 8.1.3 GNSS Direct Mode

The MIP Monitor software can be used to put the sensor in a mode wherein direct access to the internal GNSS receiver is available. In this mode the 3DM-GX5-45 normal functionality is not available, and protocol commands cannot be used. This mode is called GNSS Direct mode and is used to allow communication with the receiver through an external utility program available from the GNSS receiver manufacturer (such as u-blox) or by contacting LORD Sensing Technical Support ([see Technical Support on page 70](#)). Also refer to the *Using u-blox Software* Technical Note for specific instructions ([see Reference Documents on page 87](#)).

To start communicating with the GNSS receiver in GPS Direct mode, select Advanced > Communication > GNSS Direct from the MIP Monitor main window. Once in this mode the device status message will indicate "GNSS Direct Mode" ([Figure 41 - GNSS Direct Mode](#)).

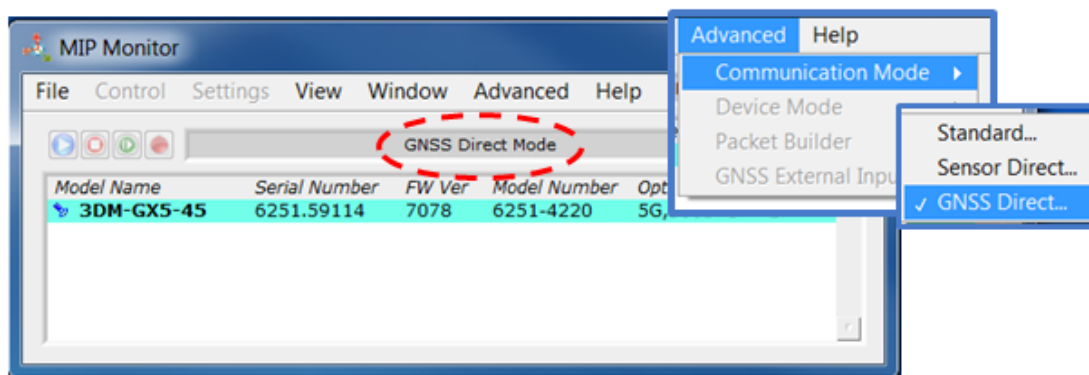

Figure 41 - GNSS Direct Mode

## 8.2 Sensor Wiring

### **WARNING**

Only use power supplies within the operating range of the sensor, or permanent sensor damage or personal injury could result. There are two input power pins available, each with different voltage ranges. Connect only one at a time. Observe connection polarity.

Sensor power and serial communications cables are available from LORD Sensing and come with the sensor starter kits. These cables will have the micro-DB9 connector on one end (to connect to the sensor) and either a standard DB9 on the other end (for RS232 communication) or a USB connector (for USB communications). Alternately, the micro-DB9 can be purchased from LORD Sensing with flying leads or the connector by itself can be purchased from the manufacturer (Ulti-Mate Connector Inc). [see Parts and Configurations on page 72](#) for a list of available options. For the cable diagram, [see Reference Diagrams on page 82](#).

The connector interface includes connections for USB and RS232 communications (only connect one), two options for sensor input power range (only connect one), and a precision hardware timing output (PPS output) for synchronizing with external timestamps. The sensor selects the appropriate serial communication (USB or RS232) on power-up based on which connection is used.

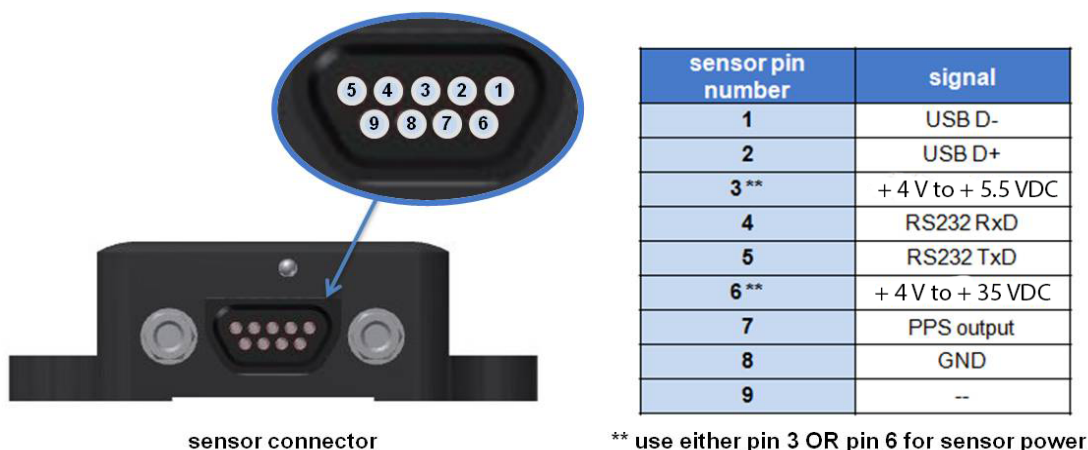

Figure 42 - Connector Wiring

### 8.3 Alternate GNSS Equipment

Other (external) GNSS receivers, antennas, and/or cables can be used with the 3DM-GX5-45. When using third party antennas, it is important to use a broadband GNSS antenna designed for receiving GPS, GLONASS, and BeiDou frequencies. Using a GPS only antenna will degrade performance. Additionally, the antenna cable length, antenna gain, and antenna power must be considered. For antennas with internal LNA (Low Noise Amplifiers) the power requirements should not have a minimum voltage below 3 volts, and the current draw should not be over 20mA. The longer the cable, the lower the signal strength, and including the antenna cable offset in GNSS outputs is advised ([see GNSS Antenna Offset on page 48](#)). The loss of signal strength can only be empirically determined by trying out a particular installation and monitoring the number of satellite links and quality of data reception from those satellites. This can be done with the MIP Monitor software ([see Global Navigation Satellite System \(GNSS\) Outputs on page 25](#)).

When using a different GNSS antenna, always use the non-magnetic MMCX-to-SMA adapter supplied with the 3DM-GX5-45 unless the magnetometer is not used in the end application.

### 8.3.1 GNSS External Receiver

To use an external GNSS receiver, the internal receiver must be disabled, and a serial link established between the receiver and the sensor through the host computer. A program is then written using the LORD Sensing MIP Data Communications Protocol to port the data from the GNSS input via the host to the sensor serial port and to translate the GNSS receiver data into the message structure the sensor processor can interpret. The data can be sent at a speed up to, but not exceeding, 20 Hz.

To set the GNSS receiver to external, open the Device Settings menu in the MIP Monitor software by selecting the sensor name in the main window (*Figure 43 - GNSS Source Select*). Select the Estimation Filter tab > EF Aiding. Set the GNSS Update Source to External GNSS Message.

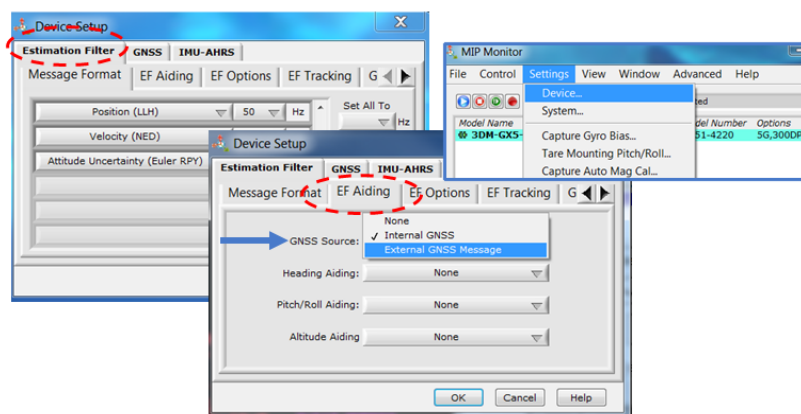

Figure 43 - GNSS Source Select

Test external GNSS messaging using the Advanced > GNSS External Input interface. This command will send a fixed external GNSS message to the device and mimic a pulse-per-second clock input (*Figure 44 - External GNSS Data*).

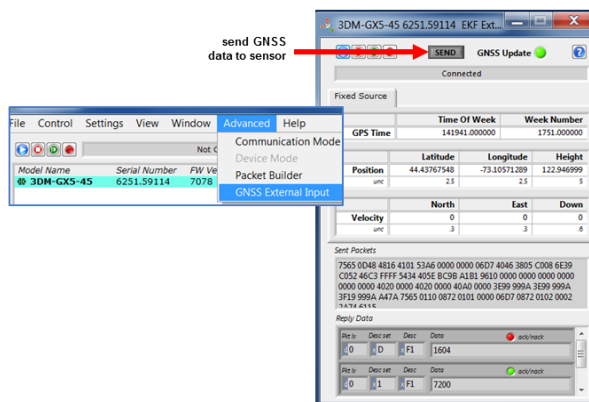

Figure 44 - External GNSS Data

## 8.4 Sampling on Start-up

The Save Current Settings command can be used to instruct the sensor to start streaming data as soon as it powered on. This can be useful in sensor integration applications in which immediate data acquisition is desired, and connection to MIP Monitor for data logging is not required. This functionality can also be embedded in user-designed applications by using the corresponding LORD Sensing MIP Data Communications Protocol command ( [see Data Communications Protocol Manual](#) for more information).

### NOTE

When setting the sensor to begin sampling on start-up, verify that the sensor is sampling by reading the status indicator on the device ( [see Interface and Indicators on page 10](#)), or by viewing the serial data stream from the host computer. If communication with MIP Monitor is established, the sampling will stop to facilitate device configuration.

To save the current sensor configuration, first adjust the sensor settings to the desired values, and then start streaming. Next select Settings > Save Current Settings from the main window ( [Figure 45 - Save Sensor Settings](#)). The setting will remain intact when the sensor is powered off and then on again.

To recall the last saved settings select Settings > Load Startup Settings.

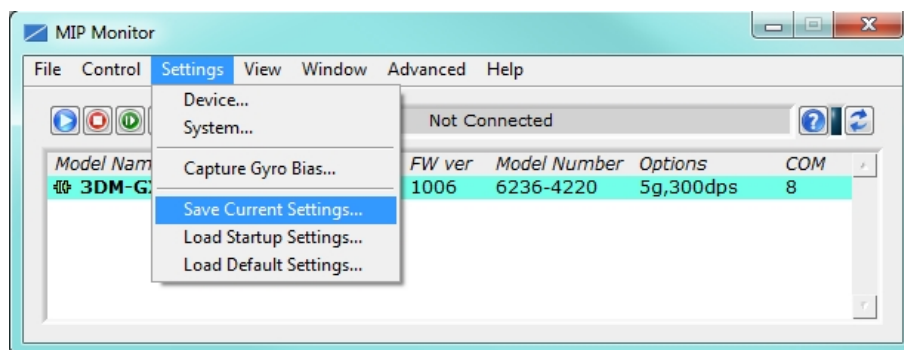

Figure 45 - Save Sensor Settings

## 8.5 Connecting to a Datalogger

Many inertial applications incorporate dataloggers of all different types to collect and distribute sensor outputs. For more information and examples refer to the "Using Dataloggers with Inertial Sensors" Technical Note on the LORD Sensing website, or contact LORD Sensing Technical Support ([see Technical Support on page 70](#)).

## 8.6 Using Wireless Adapters

In some applications it can be very useful to set up wireless communications between the sensor to the host computer. One way this can be accomplished is by connecting the serial output of the sensor to a serial to wireless converter and then connecting the wireless receiver to the host computer. For more information and an example refer to the "Using RS232 Bluetooth Adapters" Technical Note on the LORD Sensing website or contact LORD Sensing Inertial Sensor Products Technical Support ([see Technical Support on page 70](#)).



## 9. Troubleshooting

### 9.1 Troubleshooting Guide

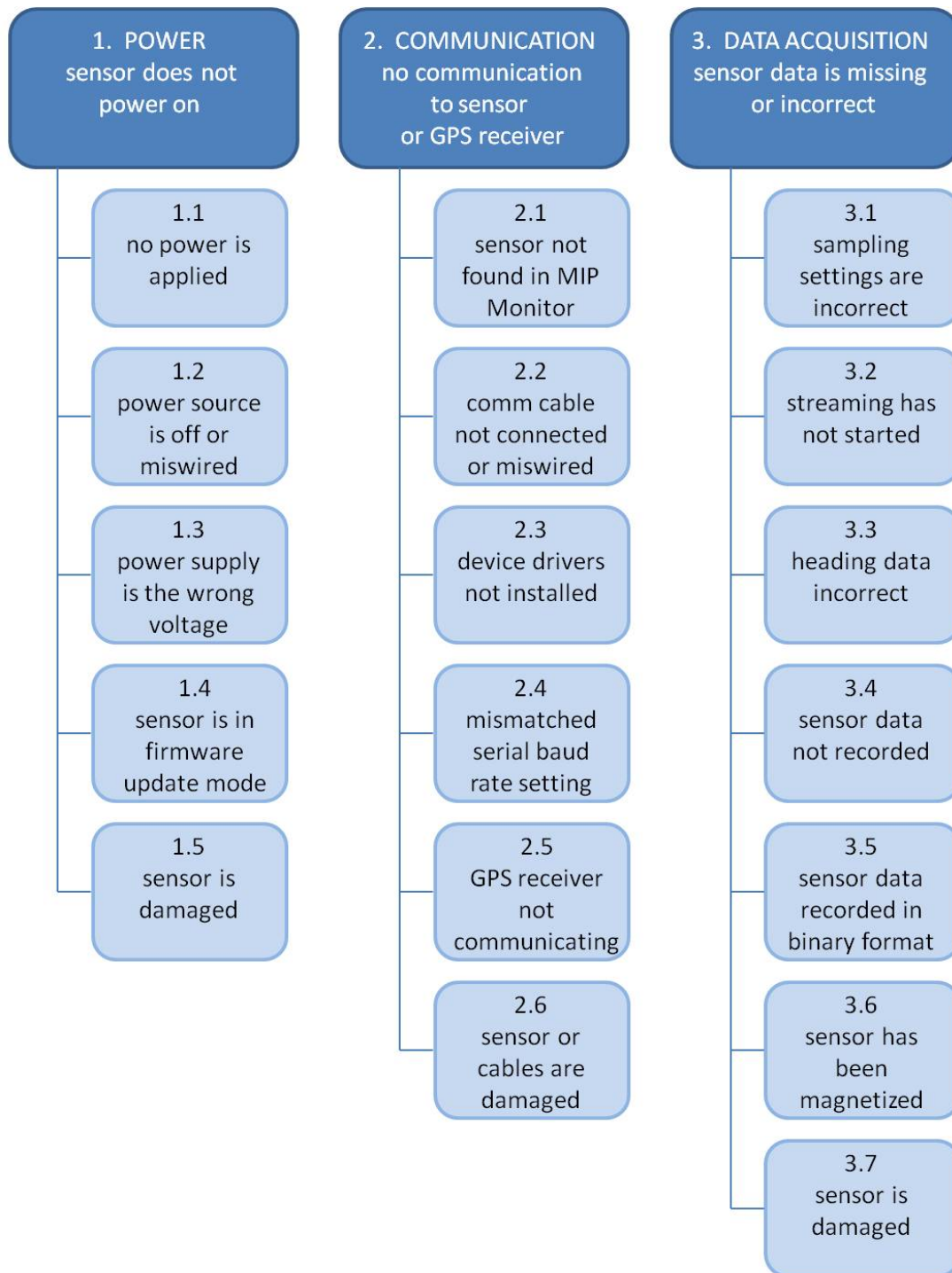

Problem	Possible cause and recommended solution
<b>1. POWER</b>  sensor does not power on	<b>1.1 no power is applied</b>  The status indicator on the device will be off. Make sure the sensor is connected to a power source and the status indicator illuminates.
	<b>1.2 power source is off or miswired</b>  Verify the device power source is connected correctly.
	<b>1.3 power supply is the wrong voltage</b>  Using a power supply other than the one provided with the device, or a supply that is outside of the device operating range, could result in permanent damage or cause it to not work properly.
	<b>1.4 sensor is in firmware update mode</b>  Firmware update mode is used when updating firmware on the device. If the firmware updater fails, it is possible that the device can get stuck in the firmware update mode, and the sensor will be non-responsive. Contact LORD Sensing Technical Support ( <a href="#">See Technical Support on page 70</a> ).
	<b>1.5 sensor is damaged</b>  If all power settings and connections have been verified, and the sensor is still unresponsive, contact LORD Sensing Technical Support ( <a href="#">See Technical Support on page 70</a> ).
<b>2. COMMUNICATION</b>  no communication to sensor or GNSS receiver	<b>2.1 sensor not found in MIP Monitor</b>  In MIP Monitor use the Refresh button to look for the sensor again. If the sensor is still not found try cycling power to the sensor and refreshing.
	<b>2.2 communication cable not connected or miswired</b>  Check, remove, and reconnect communications and power cables as applicable. Replace or rewire as needed.
	<b>2.3 device drivers not installed</b>  Verify the drivers (included with MIP Monitor Software Suite) are installed on the computer and that the software has had sufficient time to detect it. <a href="#">See Software Installation on page 12</a>
	<b>2.4 serial baud rate setting (not applicable to USB devices)</b>  The host computer serial port baud rate and the sensor baud settings must match in order for communication be established. In MIP Monitor this occurs automatically and the baud rate can only be changed once initial communication is established. To change the baud rate in MIP Monitor select Settings > System and select the desired rate.  <b>NOTE:</b> if the baud rate is set higher than the computer serial port is capable of reading, communication will be permanently lost with the device. To recover, it will need to be connected to a higher speed port, connected via USB cable, or sent to LORD Sensing for reconfiguration.
	<b>2. GNSS receiver is not communicating</b>  The GNSS antenna requires unobstructed line of sight to the

Problem	Possible cause and recommended solution
	<p>sky in order to link with the GNSS satellites. Also verify the GNSS antenna is plugged into the sensor and the cable is intact. Verify the GNSS source setting is set for an internal or external device as applicable. When using an external receiver, a receiver-to-serial translation program that utilizes the LORD Sensing MIP Data Communications Protocol is required to provide the GNSS data to the sensor.</p> <p><b>2. sensor or cables are damaged</b></p> <p>Verify all connections, power, and settings. If available, try installing an alternate cable or sensor one at a time to see if the faulty device can be identified. If no conclusion can be determined, or to send a device in for repair, contact LORD Sensing Technical Support ( <a href="#">See Technical Support on page 70</a>).</p>
<p><b>3. DATA ACQUISITION</b></p> <p>sensor data is missing or incorrect</p>	<p><b>3.1 sampling settings are incorrect</b></p> <p>If unexpected measurements or sampling rates are displayed or recorded, enter the Device Settings menu and verify the sampling settings.</p> <p><b>3.2 streaming has not started</b></p> <p>If data streaming is occurring the sensor device status indicator will also be flashing to indicate sampling. In MIP Monitor the device status information field will indicate Streaming. If the sensor is not streaming data, activate it in the software.</p> <p><b>3.3 heading data incorrect</b></p> <p>If the magnetometers have not been field-calibrated, erroneous heading data could result. If the GNSS antenna offset has not been entered, or the GNSS receiver or satellite link is not activated, it could also skew heading information.</p> <p><b>3.4 sensor data not recorded</b></p> <p>Verify data recording has been activated. In MIP Monitor the device status information field will indicate Recording Data. If the sensor isn't recording, activate in the software. Verify specific measurements have been enabled for sampling and recording.</p> <p><b>NOTE:</b>Data is recorded in time sequence. If measurements are set to different sample rates, not all time intervals will include a reading from each output that is being recorded.</p> <p><b>3.5 sensor data recorded in binary format</b></p> <p>When data recording is started the user can choose between CSV and Binary output formats. If the data is recorded in Binary format it will require a translation program that utilizes the LORD Sensing MIP Data Communications Protocol to make it readable.</p> <p><b>3.6 sensor has been magnetized</b></p> <p>Contact or close proximity with magnets may disrupt the sensor operation and cause magnetization of internal components, which can affect magnetometer performance. If magnetization is suspected, use a degaussing tool to demagnetize.</p> <p><b>3.7 sensor is damaged</b></p>

Problem	Possible cause and recommended solution
	With the sensor in a static neutral position data, look for baseline offset or drift on the IMU sensor outputs. Sensor damage can occur as a result of excessive g-force other conditions outside of its operating specifications.

## 9.2 Repair and Calibration



### General Instructions

In order to return any LORD Sensing product, you must contact LORD Sensing Sales or Technical Support to obtain a Return Merchandise Authorization (RMA) number. All returned merchandise must be in the original packaging, including manuals, accessories, cables, etc. with the RMA number clearly printed on the outside of the package. Removable batteries should be removed and packaged in separate protective wrapping. Please include the LORD Sensing model number and serial number, as well as your name, organization, shipping address, telephone number, and email. Normal turn-around for RMA items is seven days from receipt of item by LORD Sensing .



### Warranty Repairs

LORD Sensing warrants its products to be free from defective material and workmanship for a period of one (1) year from the original date of purchase. LORD Sensing will repair or replace, at its discretion, a defective product if returned to LORD Sensing within the warranty period. This warranty does not extend to any LORD Sensing products that have been subject to misuse, alteration, neglect, accident, incorrect wiring, mis-programming, or use in violation of operating instructions furnished by LORD Sensing . It also does not extend to any units altered or repaired for warranty defect by anyone other than LORD Sensing .



### Non-Warranty Repairs

All non-warranty repairs/replacements include a minimum charge. If the repair/replacement charge exceeds the minimum, LORD Sensing will contact the customer for approval to proceed beyond the minimum with the repair/replacement.

### 9.3 Technical Support

There are many resources for product support found on the LORD website including technical notes, FAQs, and product manuals.

[http://www.microstrain.com/support\\_overview.aspx](http://www.microstrain.com/support_overview.aspx)

For further assistance our technical support engineers are available to help with technical and applications questions.

#### Technical Support

[sensing\\_support@LORD.com](mailto:sensing_support@LORD.com)

Phone: 802-862-6629

SKYPE: microstrain.orientation.support

Live Chat is available from the website during business hours:  
9:00 AM to 5:00 PM (Eastern Time US & Canada)

## 10. Maintenance

There are no user-serviceable parts on the 3DM - GX5 - 45. Removing the device cover or disassembling in any way voids the product warranty.

## 11. Parts and Configurations

### 11.1 Standard Configurations

For the most current product information, custom, and OEM options not listed below, refer to the LORD Sensing website or contact the LORD Sensing Sales Department.

*Table 6 - Model Numbers* describes the standard models available at the time this manual was published. Once a model is selected, the part number is further defined by desired configuration and interface options. The model determines the first four digits of the product part number; the options are indicated in the last four digits (*Figure 46 - Standard Part Numbers*).

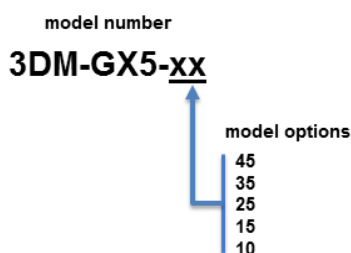

Model Number	Triaxial Accelerometers	Triaxial Gyroscope	Triaxial Magnetometer	Internal GNSS Receiver	Altitude Measurements	Auto-Adaptive Extended Kalman Filter	part number
<b>3DM-GX5-10</b>	X	X					<b>6255-xxxx</b>
<b>3DM-GX5-15</b>	X	X				X	<b>6254-xxxx</b>
<b>3DM-GX5-25</b>	X	X	X		X	X	<b>6253-xxxx</b>
<b>3DM-GX5-35</b>	X	X	X	X	X		<b>6252-xxxx</b>
<b>3DM-GX5-45</b>	X	X	X	X	X	X	<b>6251-xxxx</b>

Table 6 - Model Numbers



The same options are available in each model, and are indicated in the last four digits of the product part number. For a list of the starter kit contents, ( [see Components on page 1](#) ).

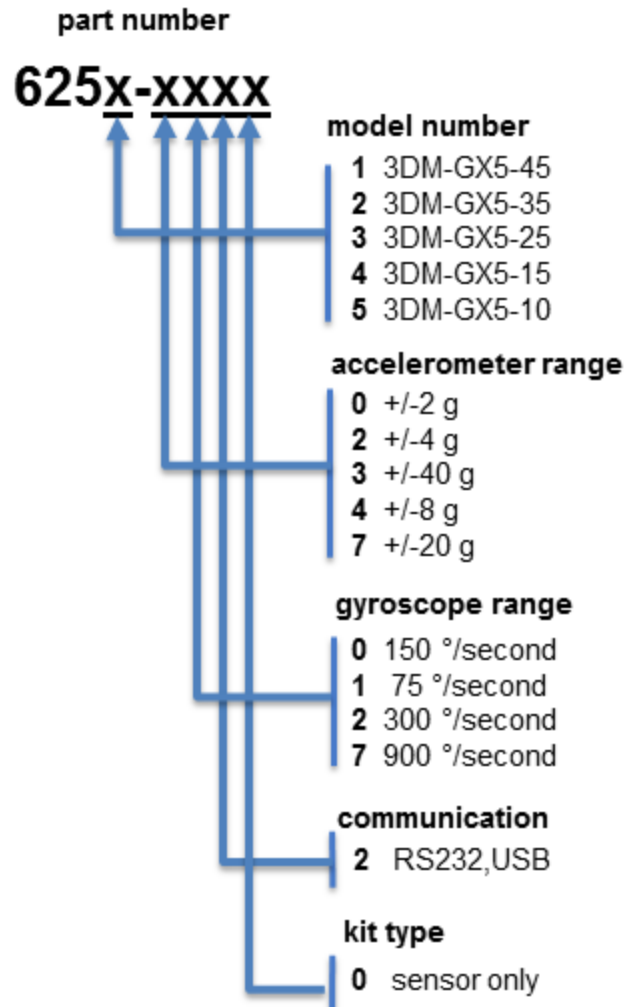

Figure 46 - Standard Part Numbers

## 11.2 Accessories

The following parts are available for use with the 3DM-GX5-45. For the most current product information refer to the LORD Sensing website or contact the Sales Department. ([see Sales Support on page 75](#)).

Description	LORD Sensing Part Number
RS232 connectivity kit	6212-3000
USB connectivity kit	6212-3002
RS232 communications cable	4005-0037
USB communications cable	9022-0019
Power supply (RS232 systems only)	9011-0009
Power supply country plug adapter kit (RS232 systems only)	9011-0022
GNSS dual feed antenna with 3m cable, SMA connector	9010-0150
Antenna cable adapter MMCX to SMA	9022-0032
MIP Monitor Software Suite flash drive	8200-0020
Sensor mating connector (micro-DB9) with flying leads	6224-0100

**Table 7 - Sensor Accessories**

Description	Manufacturer part number
"A" Series or "P" Series 9-pin male Micro-D connector	Ulti-Mate PR09N05

**Table 8 - Sensor Mating Connector**

### 11.3 Sales Support

Products can be ordered directly from the LORD Sensing website by navigating to the product page and using the Buy feature.

<http://www.microstrain.com/inertial>

For further assistance, our sales team is available to help with product selection, ordering options, and questions.

#### Sales Support

[sensing\\_sales@LORD.com](mailto:sensing_sales@LORD.com)

Phone: 802-862-6629

9:00 AM to 5:00 PM (Eastern Time US & Canada)

## 12. Specifications

General			
Integrated sensors	Triaxial accelerometer, triaxial gyroscope, triaxial magnetometer, pressure altimeter, temperature sensors and GNSS receiver		
Data outputs	<p><b>Inertial Measurement Unit (IMU) outputs:</b> acceleration, angular rate, magnetic field, ambient pressure, deltaTheta, deltaVelocity</p> <p><b>Computed outputs:</b>  <b>Extended Kalman Filter (EKF):</b> filter status, GNSS timestamp, LLH position, NED velocity, attitude estimates (in Euler angles, quaternion, orientation matrix), linear and compensated acceleration, bias compensated angular rate, pressure altitude, gyroscope and accelerometer bias, scale factors and uncertainties, gravity and magnetic models, and more.  <b>Complementary Filter (CF):</b> attitude estimates (in Euler angles, quaternion, orientation matrix), stabilized north and gravity vectors, GNSS correlation timestamp</p> <p><b>Global Navigation Satellite System outputs (GNSS):</b> LLH position, ECEF position and velocity, NED velocity, UTC time, GNSS time, SV.GNSS protocol access mode available.</p>		
Inertial Measurement Unit (IMU) Sensor Outputs			
	Accelerometer	Gyroscope	Magnetometer
Measurement range	±8 g (standard) ±2 g, ±4 g, ±20 g, ±40 g (optional)	300°/sec (standard) ±75, ±150, ±900 °/sec (optional)	±2.5 Gauss
Non-linearity	±0.02 % fs	±0.02 % fs	±0.3 % fs
Resolution	<0.1 mg	<0.003°/sec	--
Bias instability	±0.04 mg	8°/hr	--
Initial bias error	±0.002 g	±0.04°/sec	±0.003 Gauss
Scale factor stability	±0.03%	±0.05%	±0.1%
Noise density	25 µg/√Hz (2 g)	0.005°/sec/√Hz (300 dps)	100 µGauss/√Hz
Alignment error	±0.05°	±0.05°	±0.05°
Adjustable bandwidth	225 Hz (max)	250 Hz (max)	-
Offset error over temperature	0.06% (typ)	0.04% (typ)	--
Gain error over temperature	0.03% (typ)	0.03% (typ)	--
Scale factor non-linearity (@ 25° C)	0.02% (typ) 0.06% (max)	0.02% (typ) 0.06% (max)	±0.0015 Gauss
Vibration induced noise	--	0.072°/s RMS/g RMS	--
Vibration rectification error (VRE)	--	0.001°/s/g <sup>2</sup> RMS	--
IMU filtering	Digital sigma-delta wide band anti-aliasing filter to digital averaging filter (user adjustable) scaled into physical units; coning and sculling integrals computed at 1 kHz		
Sampling rate	1 kHz	4 kHz	50 Hz
IMU data output rate	1 Hz to 500 Hz (standard mode), 1 Hz to 1000 Hz (sensor direct mode)		
Pressure Altimeter			
Range	-1800 m to 10,000 m		
Resolution	< 0.1 m		
Noise density	0.01 hPa RMS		
Sampling rate	25 Hz		

Subject to change without notice

Computed Outputs	
Position accuracy	±2 m RMS horizontal, ± 5 m RMS vertical (typ)
Velocity accuracy	±0.1 m/s RMS (typ)
Attitude accuracy	EKF outputs: ±0.25° RMS roll and pitch, ±0.8° RMS heading (typ) CF outputs: ±0.5° roll, pitch, and heading (static, typ), ±2.0° roll, pitch, and heading (dynamic, typ)
Attitude heading range	360° about all axes
Attitude resolution	< 0.01°
Attitude repeatability	0.2° (typ)
Calculation update rate	500 Hz
Computed data output rate	EKF outputs: 1 Hz to 500 Hz CF outputs: 1 Hz to 500 Hz
Global Navigation Satellite System (GNSS) Outputs	
Receiver type	72-channel GPS/QZSS L1 C/A, GLONASS L10F, BeiDou B1, SBAS L1 C/A: WAAS, EGNOS, MSAS Galileo E1B/C
GNSS data output rate	1 Hz to 4 Hz
Time-to-first-fix	Cold start: 27 second, reacquisition: 1 second, hot start: <1 second
Sensitivity	Tracking: -164 dBm, cold start: -147 dBm, hot start: -156 dBm
Velocity accuracy	0.1 m/sec
Heading accuracy	0.5°
Horizontal position accuracy	GNSS: 2.5 m CEP SBAS: 2.0 m CEP
Time pulse signal accuracy	30 nsec RMS < 60 nsec 99%
Acceleration limit	≤ 4 g
Altitude limit	No limit
Velocity limit	500 m/sec (972 knots)
Operating Parameters	
Communication	USB 2.0 (full speed) RS232 (9,600 bps to 921,600 bps, default 115,200)
Power source	+4 to +36 V dc
Power consumption	700 mW (typ), 800 mW (max)
Operating temperature	-40 °C to +85 °C
Mechanical shock limit	500 g (calibration unaffected) 1000 g (bias may change), 5000 g (survivability)
MTBF	(TBD)
Physical Specifications	
Dimensions	44.2 mm x 36.6 mm x 11 mm
Weight	20 grams
Enclosure material	Aluminum
Regulatory compliance	ROHS, CE
Integration	
Connectors	Data/power output: micro-DB9 GNSS antenna: MMCX type
Software	MIP Monitor, MIP Hard and Soft Iron Calibration, Windows XP/Vista/7/8/10 compatible

<b>Compatibility</b>	Protocol compatibility across 3DM-GX3, GX4, RQ1, GQ1, and GX5 product families
<b>Software development kit (SDK)</b>	MIP data communications protocol with sample code available (OS and platform independent)

Subject to change without notice

### 12.0.1 Geodetic Frame

The World Geodetic System is the standard for cartography and navigation. The latest revision, WGS84, is the reference coordinate system for GPS, and the 3DM-GX5-45 reports position using this coordinate frame. It also calculates the magnitude of the local gravity vector using the WGS84 reference formulas.

The WGS coordinates are latitude ( $\phi$ ), longitude ( $\lambda$ ), and height ( $h$ ) above the reference ellipsoid. Latitude ranges from -90 degrees at the South Pole to 90 degrees at the North Pole. Longitude ranges from -180 to 180 degrees, with 0 degrees being the prime meridian. The -180/180 degree switchover occurs in the middle of the Pacific Ocean and includes a section of the International Date Line. The model takes into account the oblateness of the Earth's surface.

A point (P) on or above the Earth in the WGS84 coordinate system is notated as: latitude ( $\phi$ ), longitude ( $\lambda$ ), and height above the reference ellipsoid ( $h$ ).

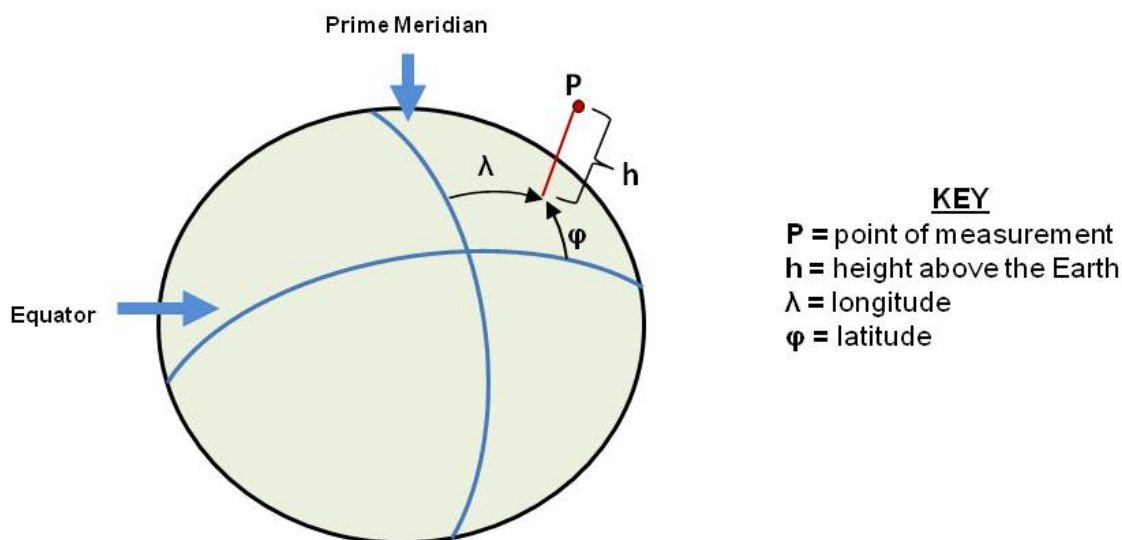

Figure 47 - World Geodetic System (WGS84) Reference Ellipsoid



## 13. Safety Information

This section provides a summary of general safety precautions that must be understood and applied during operation and maintenance of components in the LORD Sensing Inertial Sensor Products. Throughout the manual, ANSI Z535 standard safety symbols are used to indicate a process or component that requires cautionary measures.

### **WARNING**

Situations in which potentially hazardous conditions exist that could result in death or serious injury of workers and/or the general public if not avoided.

### **CAUTION**

Situations where a non-immediate or potential hazard presents a lesser threat of injury that could result in minor or moderate injury to workers and/or the general public.

### **NOTICE**

Situations where a non-immediate or potential hazard presents a risk to damage of property and equipment. May be used to indicate important operational conditions.

### 13.1 Disposal and Recycling

#### **WARNING**

#### **CAUTION**

#### **NOTICE**



The 3DM-GX5-45 contains internal printed circuit boards and electronic components. These items are known to contain toxic chemicals and heavy metals that are harmful to humans health and the environment. Disposal is subject to federal and local laws. Do not discard the device in the trash. Follow proper electronic waste disposal protocol, as dictated by federal and local authorities. Some states also have programs for extracting reusable parts for recycling.

## 14. Addendum

### 14.1 Reference Diagrams

The diagrams in this section are to intended to aid in product installation and troubleshooting. For more information contact LORD Sensing Technical Support ([see Technical Support on page 70](#)).

#### 14.1.1 Sensor Dimensions and Origin

This diagram describes the sensor physical specification including the measurement point of origin.

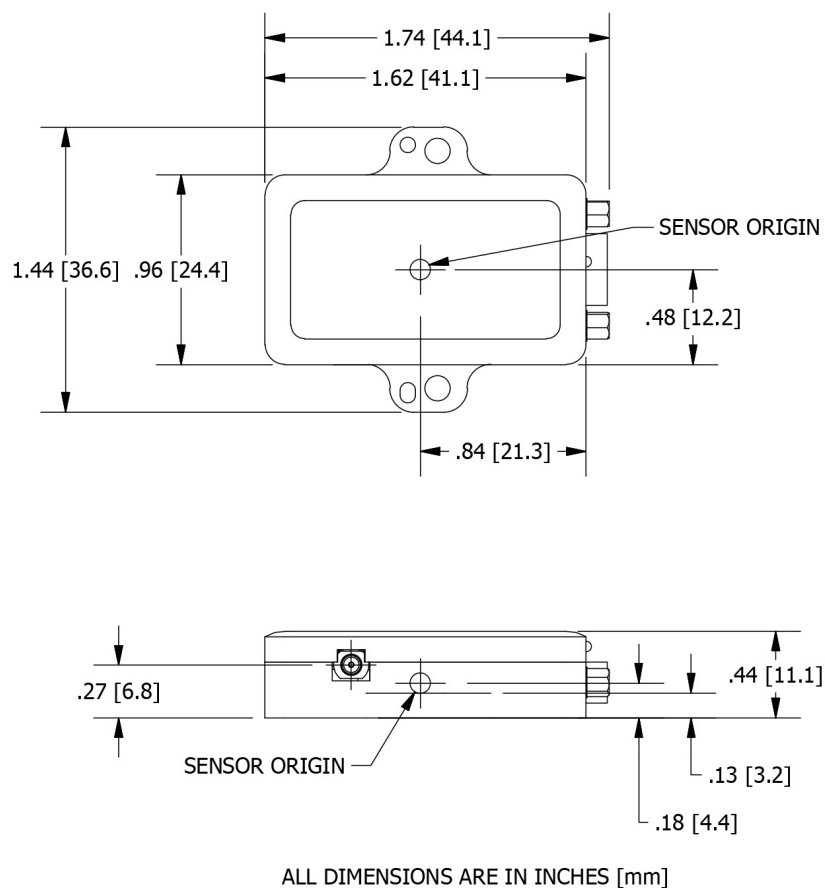
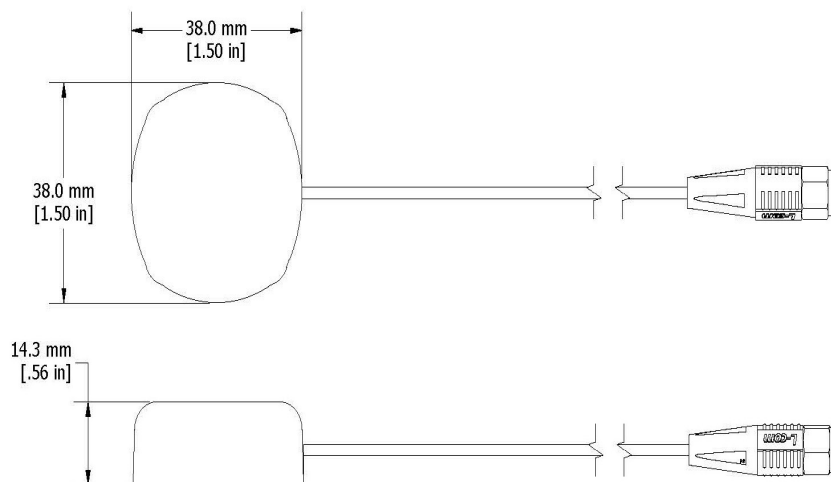

Figure 48 - 3DM-GX5-45 Sensor Origin

### 14.1.2 GNSS Antenna Specifications

These specifications describe the GNSS antenna included in the 3DM-GX5-45 connectivity kit.



Physical Specifications	
Construction	ASA plastic
Dimensions	38 mm x 38 mm x 14.3 mm
Weight	50 g (without cable and connector)
Standard mounting	Adhesive, such as double-sided tape
Cable	3 m RG174 (standard)
Connector	SMA straight 180 male
Overall Performance	
Center Frequency	1582.5 MHz
Gain	26 dB (minimum)
Noise figure	1.0 dB (typical)
VSWR	< 1.5:1 (at LNA output)
Output impedance	50 ohm
Operating temperature	-40 °C to ~+85 °C
Storage temperature	-50 °C to ~+90 °C
Relative humidity	95% non-condensing
Antenna Element	
Polarization	RHCP (Right Hand Circular Polarization)
Absolute gain at zenith	+5 dBi typical
Gain at 10° elevation	-1 dBi typical
Axial ratio	< 2 dB (typical), 3 dB (max), over full bandwidth
Low Noise Amplifier	
Gain	4.5 dBic @1582.5 MHz (with 100 mm ground plane)
Bandwidth	1559 MHz to 1606 MHz
Noise figure	1.0 dB (typical)
Supply voltage	1.8 to 16 V dc (12 V dc recommended maximum)
Current consumption	10 mA (typical)

### 14.1.3 Power Supply Specifications (RS232 kits only)

The power supply is only required for the RS232 devices. These specifications describe the power supply included in the 3DM-GX5-45 connectivity kit.

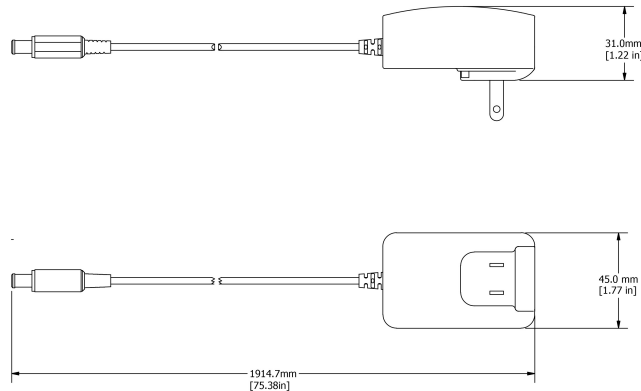

Operating Parameters	
AC input voltage rating	100 to 240 V ac
AC input voltage range	90 to 264 V ac
AC input frequency range	47 to 63 Hz
AC input current	0.25 A (RMS) maximum @ 120 V ac 0.125 A (RMS) maximum @ 240 V ac
Leakage current	0.25 mA maximum @ 254 V ac
Inrush current (cold start @ 25 °C)	< 30 A for 120V ac @ maximum load < 60 A for 240 V ac @ maximum load
Input power saving (at no load)	0.3 W maximum
DC voltage rating	9 V dc
DC load capacity	0.56 A maximum
Ripple	90 mV peak to peak maximum
Regulation	± 5 % line and load
Efficiency	≥ 72.3 % average
Hold-up time	10 mS @ 120 V ac and maximum load
Circuit protection	> 120 %, auto restart
Over-voltage protection	> 120 %, zener clamp
Safety approvals	cUL/UL, TUV, SAA, CE, C-Tick, GS, EISA, N136
Environmental Parameters	
Operating temperature	0 °C to +40 °C
Storage temperature	-25 °C to +85 °C
Humidity	10 to 90 %
Emissions	FCC Class B, EN55022 Class B
Dielectric withstanding (hi-pot) test	primary to secondary: 3000 V ac
Physical Specifications	
Dimensions	71.7 mm x 45 mm x 28.9 mm
Weight	120 g
DC output connector	2.1 mm x 5.5 mm center positive standard
Mating connector	Kycon KLD-0202-A or equivalent

### 14.1.4 Communication and Power Cables

These diagrams describe the cables included in the 3DM-GX5-45 connectivity kits. Only one is included in each kit, depending on the type of kit ordered.

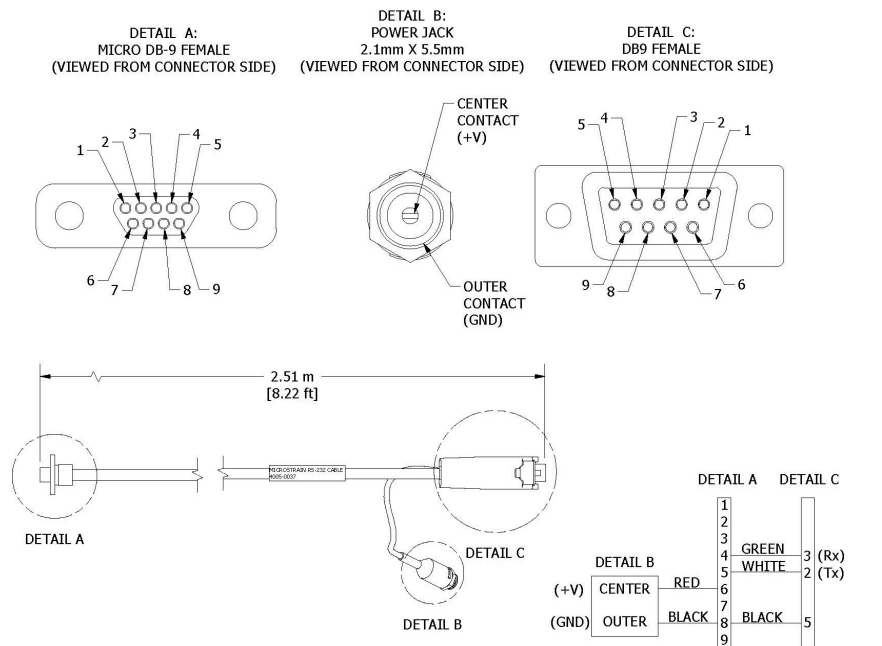

Figure 49 - Communications and power cable (RS232 Kits, PN: 4005-0037)

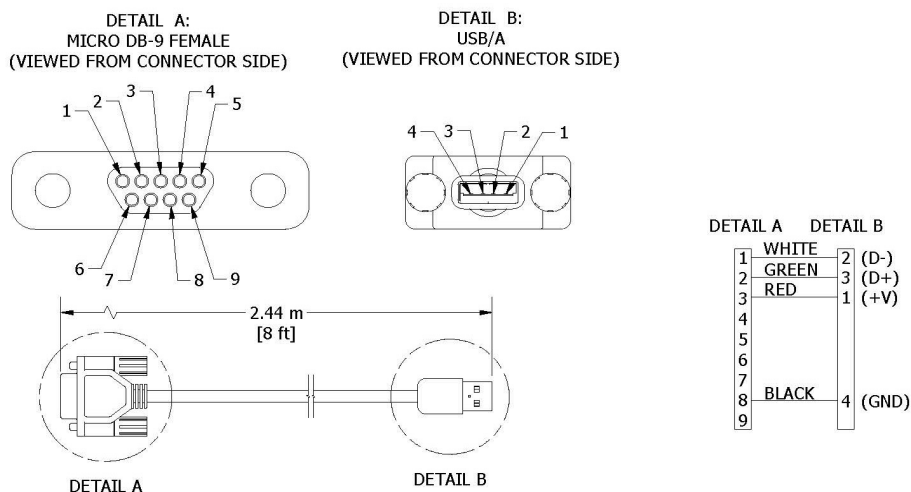

Figure 50 - Communications cable (USB Kits, PN: 9022-0019)

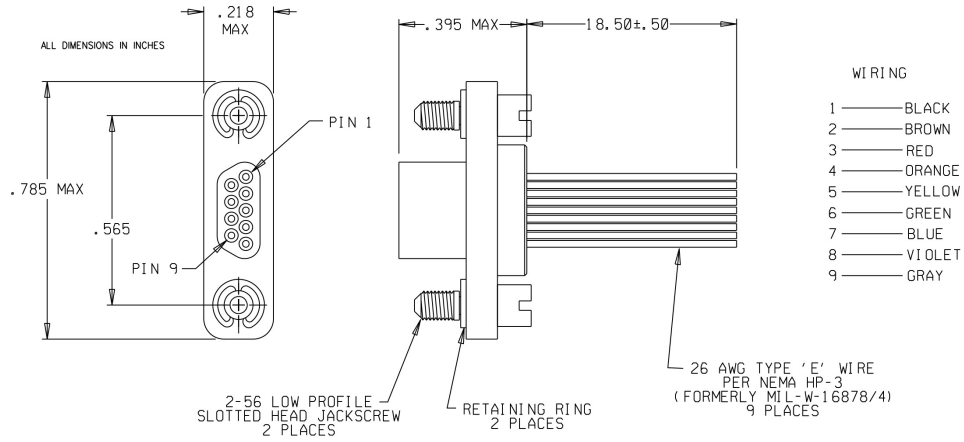

Figure 51 - Connector interface cable (sold separately, PN: 6224-0100)

## 14.2 Reference Documents

Many references are available on the LORD Sensing website including product user manuals, technical notes, and quick start guides. These documents are continuously updated and may provide more accurate information than printed or file copies.

Document	Where to find it
3DM-GX5-45 Software Developers Kit	<a href="http://www.microstrain.com/software-development-kits-sdks">http://www.microstrain.com/software-development-kits-sdks</a>
3DM-GX5-45	<a href="http://www.microstrain.com/support/docs">http://www.microstrain.com/support/docs</a>
Product Technical Notes	<a href="http://www.microstrain.com/support/docs">http://www.microstrain.com/support/docs</a>
Product Application Notes	<a href="http://www.microstrain.com/applications">http://www.microstrain.com/applications</a>
Product Datasheets	<a href="http://www.microstrain.com/lord-microstrain-inertial-sensors-all-products">http://www.microstrain.com/lord-microstrain-inertial-sensors-all-products</a>
NIST Calibration Procedures	<a href="http://www.nist.gov/calibrations/">http://www.nist.gov/calibrations/</a>
ASTM Testing Procedures	<a href="http://www.astm.org/Standard/standards-and-publications.html">http://www.astm.org/Standard/standards-and-publications.html</a>

Table 9 - Document Resources

## 14.3 Glossary